

LAGAN

GB

DE

FR

IT

PT

ES

NL

DK

NO

FI

SE



Design and Quality
IKEA of Sweden

| | |
|-------------------|-----------|
| ENGLISH | 5 |
| DEUTSCH | 10 |
| FRANÇAIS | 15 |
| ITALIANO | 20 |
| PORTUGUÊS | 25 |
| ESPAÑOL | 30 |
| NEDERLANDS | 35 |
| DANSK | 40 |
| NORSK | 45 |
| SUOMI | 50 |
| SVENSKA | 55 |

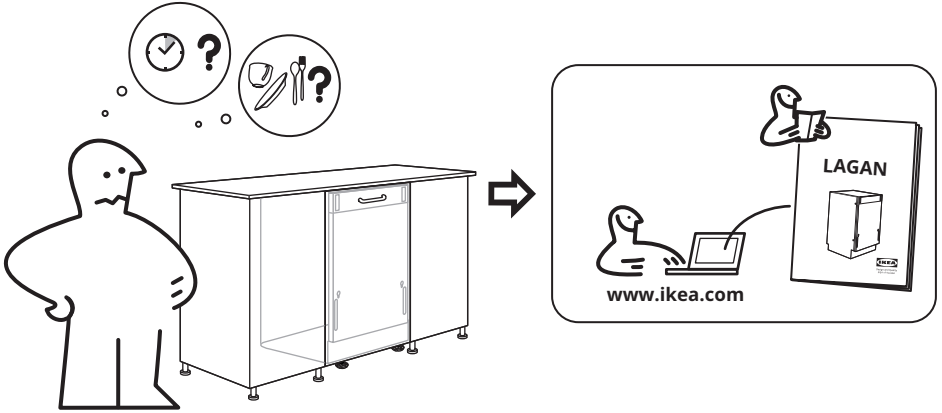

1

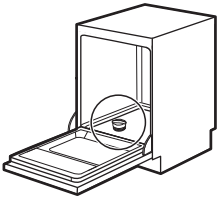

2



3



4



5

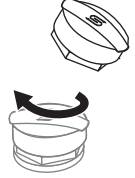

1

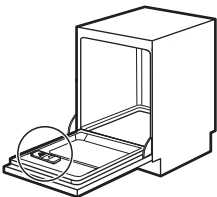

2

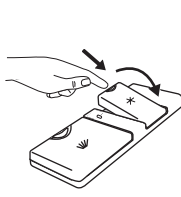

3



4



5



I

1



2



3

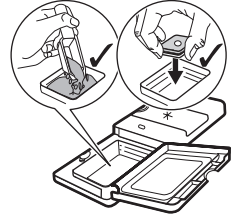

4

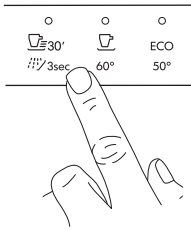

5

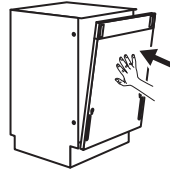

3h

1

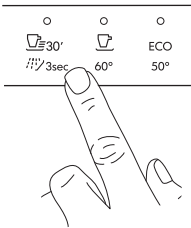

2

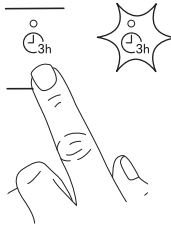

3

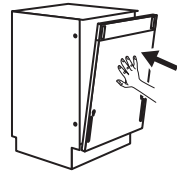

3 h

Product description

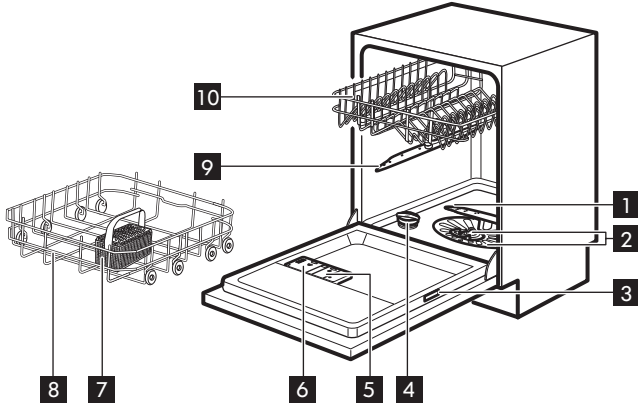



- 1 Lower spray arm
- 2 Filters
- 3 Rating plate
- 4 Salt container
- 5 Rinse aid dispenser
- 6 Detergent dispenser
- 7 Cutlery basket
- 8 Lower basket
- 9 Upper spray arm
- 10 Upper basket



Control panel









- 1 On/Off button / Reset button
- 2 Delay start button
- 3 Indicators
- 4 Programme buttons
- 5 Power Clean button
- 6 AUTO programme button

Indicators

| Indicator | Description |
|--|---|
|  | Rinse aid indicator. It is on when the rinse aid dispenser needs refilling. |
|  | Salt indicator. It is on when the salt container needs refilling. |

| Indicator | Description |
|---|---|
|  | Machine Care indicator. It is on when the appliance needs internal cleaning with the Machine Care programme. |
|  | Drying phase indicator. It is on when a programme with the drying phase is selected. It flashes when the drying phase operates. |

Programmes overview

| Programme | Dishwasher load | Degree of soil | Temperature (°C) | Time (min) | Options | AutoOpen |
|--|---|-------------------------------|------------------|------------|---|----------|
|  Quick 30' | Crockery, cutlery | Fresh soil | 50 | 30 |  | ✓ |
|  Rinse & Hold | All types of load | All degrees of soil | Cold water | 15 | ✗ | ✗ |
|  90 Minutes | Crockery, cutlery, pots, pans | Normal, lightly dried on soil | 60 | 90 |  | ✓ |
| ECO 1) | Crockery, cutlery, pots, pans | Normal, lightly dried on soil | 50 | 227 |  | ✓ |
| AUTO | Crockery, cutlery, pots, pans | All | 50 - 60 | 120 - 170 | ✗ | ✓ |
| Machine Care | For cleaning the appliance interior. Refer to "Cleaning and Maintenance". | | 70 | 60 | ✗ | ✓ |

1) This programme offers the most efficient use of water and energy consumption for crockery and cutlery with normal soil. This is the standard programme for test institutes. This programme is used to assess compliance with the Ecodesign Commission Regulation (EU) 2019/2022.

Options

You can adjust the programme selection to your needs by activating options.

option increases the wash temperature and duration.

Power Clean

 Power Clean improves the dishwashing results of the selected programme. The

Basic settings

| Number | Settings | Setting value | Water hardness | |
|--------|------------------------------|---------------|----------------|----------------------|
| | | | mmol/l | German degrees (°dH) |
| 1 | Water softener | 10 | 8.4 - 9.0 | 47 - 50 |
| | | 9 | 7.6 - 8.3 | 43 - 46 |
| | | 8 | 6.5 - 7.5 | 37 - 42 |
| | | 7 | 5.1 - 6.4 | 29 - 36 |
| | | 6 | 4.0 - 5.0 | 23 - 28 |
| | | 5 1) | 3.3 - 3.9 | 19 - 22 |
| | | 4 | 2.6 - 3.2 | 15 - 18 |
| | | 3 | 1.9 - 2.5 | 11 - 14 |
| | | 2 | 0.7 - 1.8 | 4 - 10 |
| | 1 2) | <0.7 | <4 | |
| 2 | Rinse aid empty notification | On / Off | | |
| 3 | End sound | On / Off | | |
| 4 | Auto door open | On / Off | | |
| 5 | Key tones | On / Off | | |

1) Factory setting.

2) Do not use salt at this level.

When the appliance is in setting mode, the indicators on the control panel represent available settings. For each setting, a dedicated indicator flashes:

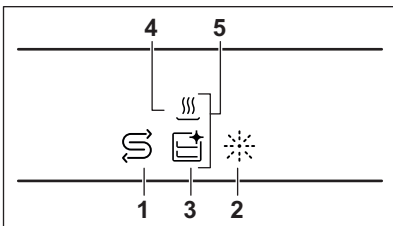

Setting mode

| Button | Description |
|--------|---|
| | Previous button. Press to switch between the basic settings and to change their values. |
| | OK button. Press to enter the selected setting and to confirm changing its value. |
| | Next button. Press to switch between the basic settings and to change their values. |

How to change a setting

1. Press and hold simultaneously 30' and **ECO** for about 3 seconds to enter setting mode.

- The light related to and the indicator flash.
- The indicators , and are on.
- The lights related to the programme buttons are on.

2. Press **Previous** or **Next** until the indicator related to the selected setting flashes.

The light related to indicates the current setting value:

- For the settings with two values (on and off), the light is either on (= the setting is on) or off (= the setting is off).
- For the settings with multiple values (levels), the light flashes. The number of flashes indicates the current setting value (e.g. 5 flashes + pause + 5 flashes... = level 5).

3. Press **OK** to enter the setting.

- The indicator related to the setting is on.
- The other indicators are off.
- The light related to indicates the current setting value.

4. Press **Previous** or **Next** to change the value.

5. Press **OK** to confirm the setting value.

- The new setting value is saved.
- The appliance returns to the basic settings list.

6. Press and hold simultaneously 30' and **ECO** for about 3 seconds to exit the setting mode.

The appliance switches to the programme selection.

AutoOpen

AutoOpen improves the drying results with less energy consumption. The appliance door opens automatically during the drying phase and remains ajar.

⚠ Caution! Do not try to close the appliance door within 2 minutes after automatic opening. This can cause damage to the appliance.

⚠ Caution! If children, pets or people with disabilities have access to the appliance, deactivate AutoOpen. The automatic opening of the door may pose a danger and expose possible hazards inside the appliance (such as knives, sharp objects, chemicals).

Before first use

Make sure that the current level of the water softener is adjusted to the hardness of the water supply.

Use the programme Quick 30' to remove residues from the manufacturing process.

1. Pour 1 litre of water in the salt container.
2. Put 1 kg of salt in the salt container. Use rough salt designed for dishwashers only.
3. Fill the rinse aid dispenser.
4. Open the water tap.
5. Select the programme Quick 30' and close the dishwasher door to start it. Do

not use detergent and do not put dishes in the baskets.

⚠ Caution! Water and salt may come out of the salt container when you fill it. After you fill the salt container, immediately start a programme to prevent corrosion.

i If you do not use the appliance, close the water tap.

Troubleshooting

If you encounter an issue with your appliance, check "Troubleshooting" chapter

in the full version of the User Manual available on: www.ikea.com.

Technical information

| | | |
|-------------------------------------|---------------------------------------|-----------------------|
| Product type | Fully integrated dishwasher | |
| Dimensions | Width / height / depth (mm) | 596 / 818 - 898 / 550 |
| Electrical connection ¹⁾ | Voltage (V) | 220 - 240 |
| | Frequency (Hz) | 50 |
| Water supply pressure | Min. / max. bar (MPa) | 0.5 (0.05) / 10 (1.0) |
| Water supply | Cold water or hot water ²⁾ | max 60 °C |

| | | |
|----------|----------------|----|
| Capacity | Place settings | 13 |
|----------|----------------|----|

1) Refer to the rating plate for other values.
 2) If the hot water comes from alternative source of energy, (e.g. solar panels, aeolian energy), use the hot water supply to decrease energy consumption.

Link to the EU EPREL database

The QR code on the energy label supplied with the appliance provides a web link to the registration of this appliance in the EU EPREL database. Keep the energy label for

reference together with the user manual and all other documents provided with this appliance.

It is possible to find information related to the performance of the product in the EU EPREL database using the link <https://eprel.ec.europa.eu> and the model name and product number that you can find on the rating plate of the appliance. Refer to the chapter "Product description".

For more detailed information about the energy label, visit www.theenergylabel.eu.

Produktbeschreibung

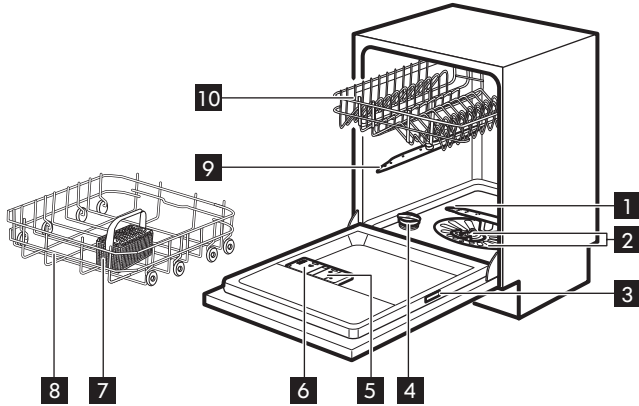



- 1 Unterer Sprüharm
- 2 Siebe
- 3 Typenschild
- 4 Salzbehälter
- 5 Klarspülmittel-Dosierer
- 6 Reinigungsmittel-Spender
- 7 Besteckkorb
- 8 Unterer Korb
- 9 Oberer Sprüharm
- 10 Oberer Korb

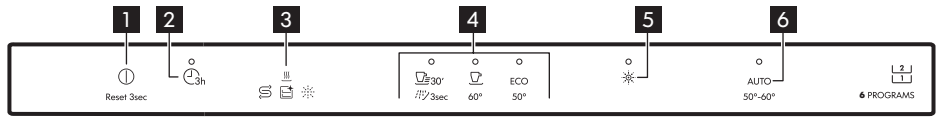

Bedienfeld









- 1 Ein-/Aus-Taste / Reset-Taste
- 2 Taste Zeitvorwahl
- 3 Anzeigen
- 4 Programmtasten
- 5 Taste Power Clean
- 6 Programmtaste AUTO

Anzeigen

| Anzeige | Beschreibung |
|--|--|
|  | Klarspülmittelanzeige. Leuchtet, wenn der Klarspülmittel-Dosierer nachgefüllt werden muss. |
|  | Salzanzeige. Leuchtet, wenn der Salzbehälter nachgefüllt werden muss. |

| Anzeige | Beschreibung |
|---|---|
|  | Machine Care-Anzeige. Leuchtet, wenn der Geräteinnenraum mit dem Programm Machine Care gereinigt werden muss. |
|  | Trocknungsphasenanzeige. Leuchtet, wenn ein Programm mit Trocknungsphase gewählt wurde. Blinkt während der Trocknungsphase. |

Programmübersicht

| Programm | Beladung der Spülmaschine | Verschmutzungsgrad | Temperatur (°C) | Zeit (Min.) | Optionen | AutoOpen |
|--|--|---|-----------------|-------------|---|----------|
|  Quick 30' | Geschirr, Besteck | Frische Verschmutzung | 50 | 30 |  | ✓ |
|  Rinse & Hold | Alle Arten von Beladung | Alle Arten von Verschmutzung | Kaltes Wasser | 15 | ✗ | ✗ |
|  90 Minutes | Geschirr, Besteck, Töpfe, Pfannen | Normale, leicht angetrocknete Verschmutzung | 60 | 90 |  | ✓ |
| ECO 1) | Geschirr, Besteck, Töpfe, Pfannen | Normale, leicht angetrocknete Verschmutzung | 50 | 227 |  | ✓ |
| AUTO | Geschirr, Besteck, Töpfe, Pfannen | Alle | 50 - 60 | 120 - 170 | ✗ | ✓ |
| Machine Care | Zum Reinigen des Innenraums des Geräts. Siehe „Reinigung und Wartung“. | | 70 | 60 | ✗ | ✓ |

1) Dieses Programm gewährleistet den wirtschaftlichsten Wasser- und Energieverbrauch für normal verschmutztes Geschirr und Besteck. Dies ist das Standardprogramm für Prüfinstitute. Dieses Programm dient der Überprüfung der Einhaltung der Verordnung der Ecodesign-Kommission (EU) 2019/2022.

Optionen

Sie können die Programmwahl durch das Einschalten von Optionen an Ihre Bedürfnisse anpassen.

Power Clean

 Power Clean verbessert die Spülergebnisse des ausgewählten Programms. Die Option erhöht die Spültemperatur und die Programmdauer.

Grundeinstellungen

| Nummer | Einstellungen | Einstellen des Wertes | Wasserhärte | |
|--------|--------------------------------|-----------------------|-------------|---------------------------------|
| | | | mmol/l | Deutsche Wasserhärtegrade (°dH) |
| 1 | WASSERENTHÄRTER | 10 | 8.4 - 9.0 | 47 - 50 |
| | | 9 | 7.6 - 8.3 | 43 - 46 |
| | | 8 | 6.5 - 7.5 | 37 - 42 |
| | | 7 | 5.1 - 6.4 | 29 - 36 |
| | | 6 | 4.0 - 5.0 | 23 - 28 |
| | | 5 1) | 3.3 - 3.9 | 19 - 22 |
| | | 4 | 2.6 - 3.2 | 15 - 18 |
| | | 3 | 1.9 - 2.5 | 11 - 14 |
| | | 2 | 0.7 - 1.8 | 4 - 10 |
| | 1 2) | <0.7 | <4 | |
| 2 | Klarspülmittel-nachfüllanzeige | Ein / Aus | | |
| 3 | Endsignal | Ein / Aus | | |
| 4 | Autom. Tür öffnen | Ein / Aus | | |
| 5 | Tastentöne | Ein / Aus | | |

1) Werkseinstellung.

2) Verwenden Sie bei diesem Grad kein Salz.

Wenn sich das Gerät im Einstellmodus befindet, repräsentieren die Kontrolllampen auf dem Bedienfeld verfügbare Einstellungen. Für jede Einstellung blinkt eine Kontrolllampe:

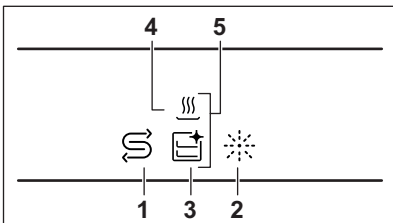

Einstellmodus

| Taste | Beschreibung |
|-------|---|
| 1h | Zurück-Taste Drücken Sie diese Taste, um zwischen den Grundeinstellungen umzuschalten und ihre Werte zu ändern. |

| Taste | Beschreibung |
|-------|---|
| | OK-Taste Drücken Sie diese Taste, um die gewünschte Einstellung aufzurufen, und bestätigen Sie die Änderung des Wertes. |
| | Weiter-Taste Drücken Sie diese Taste, um zwischen den Grundeinstellungen umzuschalten und ihre Werte zu ändern. |

Ändern einer Einstellung

- Halten Sie zum Aufrufen des Einstellmodus 30' und **ECO** gleichzeitig etwa 3 Sekunden gedrückt.
 - Die Kontrolllampe von und die Anzeige blinken.
 - Die Anzeigen , und leuchten.
 - Die Kontrolllampen der Programmtasten leuchten.
- Drücken Sie **Zurück** oder **Weiter** bis die mit der ausgewählten Einstellung verbundene Anzeige blinkt.

Die Kontrolllampe von zeigt den aktuellen Einstellwert an:

- Bei den Einstellungen mit zwei Optionen (Ein und Aus) leuchtet die Kontrolllampe (Einstellung eingeschaltet) oder sie leuchtet nicht (Einstellung ausgeschaltet).
 - Bei den Einstellungen mit mehreren Optionen (Stufen) leuchtet die Kontrolllampe. Die Anzahl der Blinkzeichen zeigt die aktuelle Einstellung an (z. B. 5 Blinkzeichen + Pause + 5 Blinkzeichen... = Stufe 5).
- Drücken Sie die Taste **OK**, um die Einstellung zu öffnen.
 - Die Lampe der Einstellung leuchtet.
 - Die anderen Kontrolllampen sind ausgeschaltet.
 - Die Kontrolllampe von zeigt den aktuellen Einstellwert an.
 - Drücken Sie **Zurück** oder **Weiter**, um den Wert zu ändern.
 - Drücken Sie **OK** zur Bestätigung der Einstellung.

- Der neue Einstellungswert wird gespeichert.
- Das Gerät kehrt zur Liste der Grundeinstellungen zurück.

6. Halten Sie  30' und **ECO** etwa 3 Sekunden gleichzeitig gedrückt, um den Einstellmodus zu beenden.

Das Gerät schaltet auf die Programmauswahl.

AutoOpen

AutoOpen verbessert die Trocknungsergebnisse bei geringerem Energieverbrauch. Die Gerätetür öffnet sich automatisch während der Trocknungsphase und bleibt einen Spaltbreit geöffnet.



Vorsicht! Versuchen Sie nicht, die Gerätetür innerhalb der ersten 2 Minuten nach der automatischen Öffnung zu schließen. Dies kann zu Schäden am Gerät führen.



Vorsicht! Wenn Kinder, Haustiere oder Menschen mit Behinderungen Zugang zum Gerät haben, deaktivieren Sie AutoOpen. Das automatische Öffnen der Tür kann Gefahren im Inneren des Geräts freilegen (z. B. Messer, scharfe Gegenstände, Chemikalien).

Vor der ersten Verwendung

Stellen Sie sicher, dass das aktuelle Niveau des Wasserenthärterers auf die Härte der Wasserversorgung eingestellt ist.

Verwenden Sie das Quick 30' Programm, um Rückstände aus dem Herstellungsprozess zu entfernen.

1. Gießen Sie 1 Liter Wasser in den Salzbehälter.
2. Geben Sie 1 kg Salz in den Salzbehälter. Verwenden Sie ausschließlich speziell für Geschirrspüler bestimmtes grobkörniges Salz.
3. Füllen des Klarspülerdosierers.
4. Öffnen Sie den Wasserhahn.
5. Wählen Sie das Programm Quick 30' und schließen Sie die Tür des Geschirrspülers,

um es zu starten. Verwenden Sie kein Reinigungsmittel und beladen Sie die Körbe nicht.



Vorsicht! Beim Befüllen des Salzbehälters können Wasser und Salz austreten. Starten Sie nach dem Füllen des Salzbehälters umgehend ein Programm, um Korrosion zu verhindern.



Wenn Sie das Gerät nicht verwenden, schließen Sie den Wasserhahn.

Problembekämpfung

Wenn Sie ein Problem mit Ihrem Gerät haben, lesen Sie das Kapitel „Fehlerbehebung“ in der Vollversion des

Benutzerhandbuchs, das auf folgenden Seiten verfügbar ist: www.ikea.com.

Technische Daten

| | | |
|--------------------------------------|--|-----------------------|
| Gerätetyp | Vollständig integrierte Spülmaschine | |
| Abmessungen | Breite/Höhe/Tiefe (mm) | 596 / 818 - 898 / 550 |
| Elektrischer Anschluss ¹⁾ | Spannung (V) | 220 - 240 |
| | Frequenz (Hz) | 50 |
| Druck der Wasserversorgung | Min./max. bar (MPa) | 0.5 (0.05) / 10 (1.0) |
| Wasserzufuhr | Kaltes Wasser oder heißes Wasser ²⁾ | max. 60 °C |
| Fassungsvermögen | Einstellungen vornehmen | 13 |

1) Weitere Werte finden Sie auf dem Typenschild.

2) Wenn das heiße Wasser von einer alternativen Energiequelle (z. B. Solaranlage, Äolenkraft) kommt, dann verwenden Sie die Warmwasserversorgung, um den Energieverbrauch zu reduzieren.

Link zur EU EPREL-Datenbank

Der QR-Code auf der Energieplakette des Geräts bietet einen Web-Link zur Registrierung des Geräts in der EU EPREL-Datenbank. Bewahren Sie daher die Energieplakette als Referenz zusammen mit dieser Bedienungsanleitung und allen anderen Unterlagen, die mit dem Gerät geliefert wurden, auf.

Informationen bezüglich der Geräteleistung finden Sie in der EU EPREL-Datenbank mit Hilfe des Links <https://eprel.ec.europa.eu> sowie mit dem Modellnamen und der Produktnummer, die Sie auf dem Typenschild des Geräts finden. Siehe Kapitel „Gerätebeschreibung“.

Weitere Einzelheiten zur Energieplakette finden Sie auf www.theenergylabel.eu.

Description de l'appareil

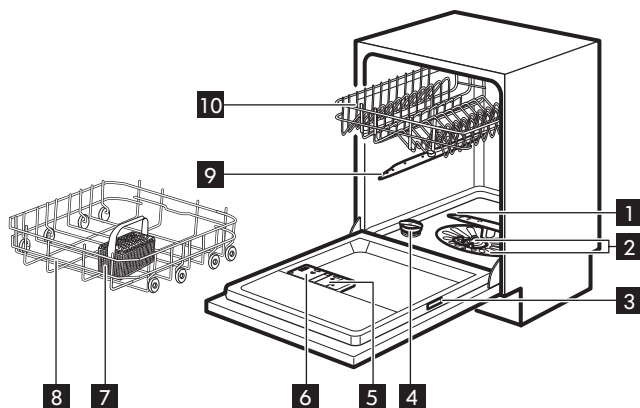



- | | |
|---|-------------------------------------|
| 1 Bras d'aspersion inférieur | 7 Panier à couverts |
| 2 Filtres | 8 Panier inférieur |
| 3 Plaque signalétique | 9 Bras d'aspersion supérieur |
| 4 Réservoir de sel régénérant | 10 Panier supérieur |
| 5 Distributeur de liquide de rinçage | |
| 6 Distributeur de détergent | |



Bandeau de commande









- | | |
|---|-----------------------------------|
| 1 Touche Marche/Arrêt / Touche Réinitialiser | 4 Touches de programme |
| 2 Touche Départ différé | 5 Power Clean touche |
| 3 Voyants | 6 AUTO Touche de programme |

Voyants

| Voyant | Description |
|--|---|
|  | Voyant du liquide de rinçage. Il s'allume lorsque le distributeur de liquide de rinçage doit être rempli. |
|  | Voyant du sel de rinçage. Il s'allume lorsque le réservoir de sel régénérant doit être rempli. |

| Voyant | Description |
|---|---|
|  | Voyant Machine Care. Il s'allume lorsque l'appareil nécessite un nettoyage interne avec le programme Machine Care. |
|  | Voyant de phase de séchage. Il s'allume lorsque vous sélectionnez un programme avec la phase de séchage. Il clignote au cours de la phase de séchage. |

Présentation des programmes

| Programme | Charge du lave-vaisselle | Degré de salissure | Température (°C) | Durée (min) | Options | AutoOpen |
|--|---|---------------------------------------|------------------|-------------|---|----------|
|  Quick 30' | Vaisselle, couverts | Salissure récente | 50 | 30 |  | ✓ |
|  Rinse & Hold | Tous types de vaisselle | Tous degrés de salissure | Eau froide | 15 | ✗ | ✗ |
|  90 Minutes | Vaisselle, couverts, casseroles et poêles | Encrassement normal et légèrement sec | 60 | 90 |  | ✓ |
| ECO 1) | Vaisselle, couverts, casseroles et poêles | Encrassement normal et légèrement sec | 50 | 227 |  | ✓ |
| AUTO | Vaisselle, couverts, casseroles et poêles | Tous | 50 - 60 | 120 - 170 | ✗ | ✓ |
| Machine Care | Nettoyage de l'intérieur de l'appareil. Se reporter à « Nettoyage et entretien ». | | 70 | 60 | ✗ | ✓ |

1) Ce programme vous permet d'optimiser votre consommation d'eau et d'énergie pour la vaisselle et les couverts normalement sales. Il s'agit du programme standard pour les instituts de tests. Ce programme permet d'évaluer la conformité avec la réglementation de la Commission (UE) 2019/2022 Ecodesign.

Options

Vous pouvez ajuster le programme sélectionné en fonction de vos besoins en activant les options.

Power Clean

 Power Clean améliore les résultats de lavage vaisselle du programme sélectionné. Cette option augmente la durée et la température de lavage.

Réglages de base

| Numéro | Configurations | Valeur de réglage | Dureté de l'eau | |
|--------|---|-------------------|-----------------|------------------------|
| | | | mmol/l | Degrés allemands (°dH) |
| 1 | Adoucisseur d'eau | 10 | 8.4 - 9.0 | 47 - 50 |
| | | 9 | 7.6 - 8.3 | 43 - 46 |
| | | 8 | 6.5 - 7.5 | 37 - 42 |
| | | 7 | 5.1 - 6.4 | 29 - 36 |
| | | 6 | 4.0 - 5.0 | 23 - 28 |
| | | 5 1) | 3.3 - 3.9 | 19 - 22 |
| | | 4 | 2.6 - 3.2 | 15 - 18 |
| | | 3 | 1.9 - 2.5 | 11 - 14 |
| | | 2 | 0.7 - 1.8 | 4 - 10 |
| | 1 2) | <0.7 | <4 | |
| 2 | Notification du distributeur de liquide de rinçage vide | Marche / Arrêt | | |
| 3 | Signal sonore de fin | Marche / Arrêt | | |
| 4 | Ouverture automatique de la porte | Marche / Arrêt | | |
| 5 | Tonalités des touches | Marche / Arrêt | | |

1) Réglages Usine.

2) N'utilisez pas de sel à ce niveau.

Lorsque l'appareil est en mode Programmation, les voyants sur le bandeau de commande représentent les réglages disponibles. Pour chaque réglage, un voyant dédié clignote :

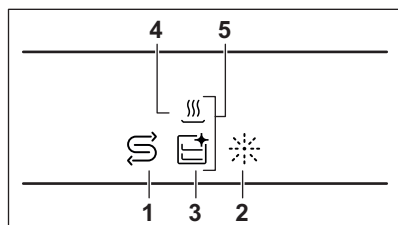

Mode Configuration

| Touche | Description |
|--------|--|
| 1h | Départ/Pause Précédent. Appuyez pour naviguer entre les réglages de base et changer leurs valeurs. |

| Touche | Description |
|--------|--|
| | Départ/Pause OK. Appuyez pour accéder au réglage sélectionné et confirmer le changement de valeur. |
| | Départ/Pause Suivant. Appuyez pour naviguer entre les réglages de base et changer leurs valeurs. |

Comment modifier le réglage

- Maintenez simultanément les touches 30' et **ECO** enfoncées pendant environ 3 secondes pour accéder au mode réglage.
 - La lumière correspondant à et l'indicateur clignotent.
 - Les voyants , et sont allumés.
 - Les voyants correspondant aux touches du programme sont allumés.
- Appuyez sur **Précédent** ou **Suivant** jusqu'à ce que l'indicateur correspondant au réglage sélectionné clignote.

Le voyant connexe indique la valeur de réglage actuelle :

- Pour les réglages à deux valeurs (marche et arrêt), le voyant est allumée (= le réglage est allumé) ou éteint (= le réglage est éteint).
 - Pour les réglages avec plusieurs valeurs (niveaux), le voyant clignote. Le nombre de clignotements indique la valeur du réglage actuel (p. ex. : 5 clignotements + pause + 5 clignotements = niveau 5).
- Appuyez sur **OK** pour accéder au réglage.
 - Le voyant correspondant à la touche est allumé.
 - Les autres voyants sont éteints.
 - Le voyant en rapport avec indique la valeur de réglage actuelle.
 - Appuyez sur **Précédent** ou sur **Suivant** pour changer la valeur.

5. Appuyez sur **OK** pour confirmer la valeur du réglage.
 - Le nouveau réglage est mémorisé.
 - L'appareil revient à la liste des réglages de base.
6. Maintenez simultanément les touches  et **ECO** enfoncées pendant environ 3 secondes pour quitter le mode réglage.

L'appareil passe au mode de sélection de programme.

AutoOpen

AutoOpen améliore le séchage tout en consommant moins d'énergie. Durant la phase de séchage, la porte s'ouvre automatiquement et reste entrouverte.



ATTENTION! Ne tentez pas de refermer la porte de l'appareil dans les 2 minutes suivant son ouverture automatique. Cela pourrait endommager l'appareil.



ATTENTION! Si des enfants, des animaux domestiques ou des personnes handicapées ont accès à l'appareil, désactivez AutoOpen. L'ouverture automatique de la porte peut présenter un danger et exposer des risques potentiels à l'intérieur de l'appareil (tels que couteaux, objets tranchants, produits chimiques).

Avant la première utilisation

Assurez-vous que le niveau actuel de l'adoucisseur d'eau correspond à la dureté de l'arrivée d'eau.

Utilisez le programme Quick 30' pour éliminer tout résidu de fabrication.

1. Versez 1 litre d'eau dans le réservoir de sel régénérant.
2. Versez 1 kg de sel dans le réservoir de sel régénérant.
Utilisez uniquement du gros sel spécialement conçu pour les lave-vaisselle.
3. Remplissez le distributeur de liquide de rinçage.
4. Ouvrez le robinet d'arrivée d'eau.

5. Sélectionnez le programme Quick 30' et fermez la porte du lave-vaisselle pour le démarrer. N'utilisez pas de produit de lavage et laissez les paniers vides.



ATTENTION! De l'eau et du sel peuvent sortir du réservoir de sel régénérant lorsque vous le remplissez. Afin d'éviter la corrosion, lancez immédiatement un programme après avoir rempli le réservoir de sel régénérant.



Si vous n'utilisez pas l'appareil, fermez le robinet d'eau.

Dépannage

Si vous rencontrez un problème avec votre appareil, consultez le chapitre « Dépannage » dans la version complète du

Manuel de l'utilisateur disponible sur : www.ikea.com.

Caractéristiques techniques

| | | |
|--------------------------------------|--|-----------------------|
| Type de produit | Lave-vaisselle parfaitement intégré | |
| Dimensions | Largeur / hauteur / profondeur (mm) | 596 / 818 - 898 / 550 |
| Branchement électrique ¹⁾ | Tension (V) | 220 - 240 |
| | Fréquence (Hz) | 50 |
| Pression de l'arrivée d'eau | Min. / max. bar (MPa) | 0.5 (0.05) / 10 (1.0) |
| Arrivée d'eau | Eau froide ou eau chaude ²⁾ | max. 60°C |
| Capacité | Configurations du nombre de couverts | 13 |

1) Reportez-vous à la plaque signalétique pour d'autres valeurs.

2) Si l'eau chaude est produite à partir de sources d'énergie respectueuses de l'environnement (par exemple des panneaux solaires, énergie éolienne), utilisez une arrivée d'eau chaude afin de réduire la consommation d'énergie.

Lien vers la base de données EPREL de l'UE

Le code QR présent sur l'étiquette énergétique fournie avec l'appareil contient un lien Web permettant d'enregistrer cet appareil dans la base de données EPREL de l'UE. Conservez l'étiquette énergétique à titre de référence avec le manuel d'utilisation et tous les autres documents fournis avec cet appareil.

Il est possible de trouver des informations relatives aux performances du produit dans la base de données EPREL de l'EU grâce au lien <https://eprel.ec.europa.eu> avec le nom du modèle et le numéro de produit se trouvant sur la plaque signalétique de l'appareil. Reportez-vous au chapitre « Description du produit ».

Pour des informations plus détaillées sur l'étiquette énergétique, consultez le site www.theenergylabel.eu.

Descrizione del prodotto

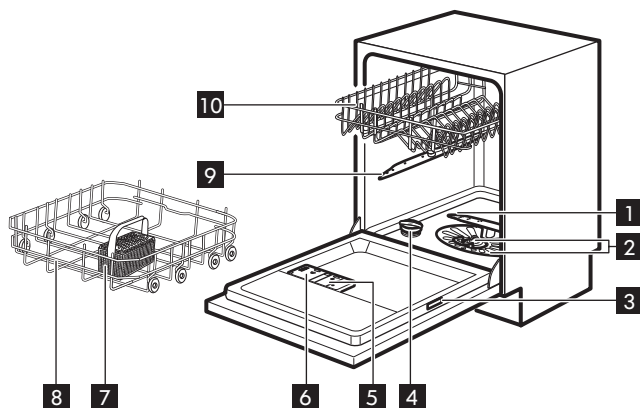



- | | |
|---------------------------------------|-------------------------------|
| 1 Mulinello inferiore | 7 Cestello portaposate |
| 2 Filtri | 8 Cestello inferiore |
| 3 Targhetta identificativa | 9 Mulinello superiore |
| 4 Contenitore del sale | 10 Cestello superiore |
| 5 Contenitore del brillantante | |
| 6 Erogatore del detersivo | |



Pannello di controllo









- | | |
|-------------------------------------|-------------------------------|
| 1 Tasto On/Off / Tasto reset | 5 Power Clean tasto |
| 2 Tasto avvio ritardato | 6 AUTO Tasto Programmi |
| 3 Spie | |
| 4 Tasti programmi | |

Spie

| Spia | Descrizione |
|--|---|
|  | Spia brillantante. La spia è accesa quando è necessario ricaricare il contenitore del brillantante. |
|  | Spia del sale. La spia è accesa quando è necessario ricaricare il contenitore del sale. |

| Spia | Descrizione |
|---|--|
|  | Indicatore Machine Care. Si accende quando l'apparecchiatura necessita una pulizia interna col programma Machine Care. |
|  | Indicatore Fase di asciugatura. È accesa quando è selezionato un programma con la fase di asciugatura. Lampeggia quando è in corso la fase di asciugatura. |

Panoramica dei programmi

| Programma | Carico lavastoviglie | Grado di sporco | Temperatura (°C) | Ora (min.) | Opzioni | AutoOpen |
|--|---|---------------------------------------|------------------|------------|---|----------|
|  Quick 30' | Stoviglie, posate | Sporco fresco | 50 | 30 |  | ✓ |
|  Rinse & Hold | Tutti i tipi di carico | Tutti i gradi di sporco | Acqua fredda | 15 | ✗ | ✗ |
|  90 Minutes | Stoviglie, posate, pentole, padelle | Sporco normale, leggermente essiccato | 60 | 90 |  | ✓ |
| ECO 1) | Stoviglie, posate, pentole, padelle | Sporco normale, leggermente essiccato | 50 | 227 |  | ✓ |
| AUTO | Stoviglie, posate, pentole, padelle | Tutte | 50 - 60 | 120 - 170 | ✗ | ✓ |
| Machine Care | Per la pulizia interna dell'apparecchiatura. Fare riferimento a "Pulizia e manutenzione". | | 70 | 60 | ✗ | ✓ |

1) Questo programma offre l'utilizzo più efficiente di acqua ed elettricità per lavare stoviglie e posate con grado di sporco normale. Questo è il programma standard per gli istituti di prova. Questo programma è utilizzato per valutare la conformità al regolamento della Commissione sulla progettazione ecocompatibile (UE) 2019/2022.

Opzioni

Sarà possibile regolare la selezione del programma sulla base delle proprie esigenze attivando le opzioni.

Power Clean

 Power Clean migliora i risultati di lavaggio del programma selezionato. Aumenta la temperatura e la durata del lavaggio.

Impostazioni base

| Numero | Impostazioni | Valore dell'impostazione | Durezza dell'acqua | |
|--------|--------------------------|--------------------------|--------------------|----------------------|
| | | | mmol/l | Gradi tedeschi (°dH) |
| 1 | Addolcitore dell'acqua | 10 | 8.4 - 9.0 | 47 - 50 |
| | | 9 | 7.6 - 8.3 | 43 - 46 |
| | | 8 | 6.5 - 7.5 | 37 - 42 |
| | | 7 | 5.1 - 6.4 | 29 - 36 |
| | | 6 | 4.0 - 5.0 | 23 - 28 |
| | | 5 1) | 3.3 - 3.9 | 19 - 22 |
| | | 4 | 2.6 - 3.2 | 15 - 18 |
| | | 3 | 1.9 - 2.5 | 11 - 14 |
| | | 2 | 0.7 - 1.8 | 4 - 10 |
| | 1 2) | <0.7 | <4 | |
| 2 | Notifica brillante vuoto | On/Off | | |
| 3 | Segnale di fine ciclo | On/Off | | |
| 4 | Apertura automatica | On/Off | | |
| 5 | Tono dei tasti | On/Off | | |

1) Impostazioni di fabbrica.

2) Non usare sale a questo livello.

Quando l'apparecchiatura si trova nella modalità impostazione, le spie sul pannello di controllo indicano le impostazioni disponibili. Per ogni impostazione lampeggia una spia dedicata:

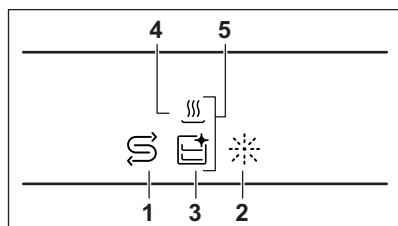

Modalità di impostazione

| Tasto | Descrizione |
|-------|--|
| 1h | Tasto Precedente. Premere per spostarsi fra le impostazioni base e modificarne il valore. |
| | Tasto OK. Premere per accedere all'impostazione selezionata e per confermare la modifica del valore. |

| Tasto | Descrizione |
|-------|---|
| | Tasto Successivo. Premere per spostarsi fra le impostazioni base e modificarne il valore. |

Come modificare un'impostazione

- Per accedere alla modalità impostazione, tenere premuti contemporaneamente 30' e **ECO** per circa 3 secondi.

- La spia legata a 3h e l'indicatore lampeggiano.
- Le spie e sono accese.
- Le spie associate ai tasti dei programmi sono accese.

- Premere **Precedente** o **Successivo** finché non lampeggia la spia relativa all'impostazione selezionata.

La spia legata a 3h indica il valore dell'impostazione attuale:

- Per le impostazioni con due valori (on e off), la spia è accesa (= l'impostazione è accesa) oppure off (= l'impostazione è spenta).
- Per le impostazioni con più valori (livelli), la luce lampeggia. Il numero dei lampeggiamenti indica il valore attuale dell'impostazione (ad es. 5 lampeggiamenti + pausa + 5 lampeggiamenti... = livello 5).

- Premere **OK** per inserire l'impostazione.

- La spia associata all'impostazione è accesa.
- Le altre spie sono disattivate.
- La spia legata a 3h indica il valore dell'impostazione attuale.

- Premi **Precedente** o **Successivo** per modificare il valore.

- Premere **OK** per confermare il valore dell'impostazione.

- Viene salvato il nuovo valore dell'impostazione.
- L'apparecchiatura torna all'elenco impostazioni di base.

- Per uscire dalla modalità impostazione tenere premuti contemporaneamente 30' e **ECO** per circa 3 secondi.

L'apparecchiatura passa alla selezione del programma.

AutoOpen

AutoOpen migliora i risultati di asciugatura con consumi elettrici ridotti. Lo sportello si apre automaticamente durante la fase di asciugatura e resta socchiuso.

-  **ATTENZIONE!** Non cercare di chiudere lo sportello dell'apparecchiatura 2 minuti dopo l'apertura automatica. Questo può danneggiare l'apparecchiatura.

-  **ATTENZIONE!** Se bambini, animali domestici o persone con disabilità hanno accesso all'apparecchiatura, disattivare AutoOpen. L'apertura automatica della porta può rappresentare un pericolo ed esporre l'apparecchiatura a possibili pericoli (come coltelli, oggetti taglienti, sostanze chimiche).

Prima del primo utilizzo

Assicurarsi che il livello corrente dell'addolcitore dell'acqua corrisponda alla durezza dell'alimentazione dell'acqua.

Utilizzare il programma Quick 30' per rimuovere i residui dal processo di fabbricazione.

1. Versare 1 litro di acqua nel contenitore del sale.
2. Mettere 1 kg di sale nel contenitore del sale.
Usare sale grosso specifico per lavastoviglie.
3. Riempire la vaschetta del brillantante.
4. Aprire il rubinetto dell'acqua.
5. Selezionare il programma Quick 30' e chiudere la porta della lavastoviglie per

avviarla. Non usare detersivo e non mettere i piatti nei cestelli.

-  **ATTENZIONE!** Acqua e sale possono fuoriuscire dal contenitore del sale durante il riempimento. Dopo aver riempito il contenitore del sale, avviare immediatamente un programma volto ad evitare la corrosione.

-  Se non si utilizza l'apparecchiatura, chiudere il rubinetto dell'acqua.

Risoluzione dei problemi

In caso di problemi con l'apparecchiatura consultare il capitolo "Risoluzione dei problemi" nella versione completa del

Manuale d'uso disponibile su:
www.ikea.com.

Informazioni tecniche

| | |
|-----------------------|---------------------------------------|
| Tipologia di prodotto | Lavastoviglie completamente integrata |
|-----------------------|---------------------------------------|

| | | |
|------------|---------------------------------------|-----------------------|
| Dimensioni | Larghezza / altezza / profondità (mm) | 596 / 818 - 898 / 550 |
|------------|---------------------------------------|-----------------------|

| | | |
|---------------------------------------|--|-----------------------|
| Collegamento elettrico ¹⁾ | Tensione (V) | 220 - 240 |
| | Frequenza (Hz) | 50 |
| Pressione di alimentazione dell'acqua | Min./max. bar (Mpa) | 0.5 (0.05) / 10 (1.0) |
| Collegamento dell'acqua | Acqua fredda o acqua calda ²⁾ | max 60°C |
| Capacità | Coperti | 13 |

1) Fare riferimento alla targhetta dei dati per altri valori.

2) Consigliamo il collegamento all'acqua calda se prodotta mediante utilizzo di una fonte di energia alternativa (per es. pannelli solari, energia eolica) per ridurre il consumo energetico.

Collegamento alla banca dati EPREL dell'UE

Il codice QR sull'etichetta energetica fornita con l'apparecchio fornisce un link web per la registrazione di questo apparecchio nella banca dati EPREL dell'UE. Conservare l'etichetta energetica come riferimento insieme al manuale d'uso e a tutti gli altri documenti forniti con questo apparecchio.

È possibile trovare le stesse informazioni correlate alle prestazioni del prodotto nella banca dati EPREL dell'UE utilizzando il link <https://eprel.ec.europa.eu> e il nome del modello e il numero di prodotto che si trovano sulla targhetta dell'apparecchio. Vedere il capitolo "Descrizione del prodotto".

Per informazioni dettagliate sull'etichetta energetica, vedere www.theenergylabel.eu.

Descrição do produto

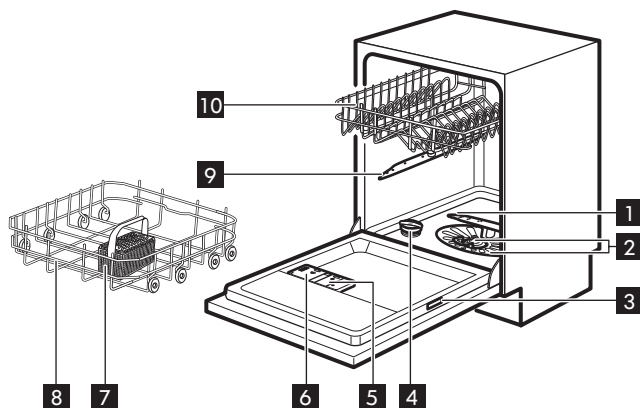

- 1** Braço aspersor inferior
- 2** Filtros
- 3** Placa de classificação
- 4** Depósito de sal
- 5** Distribuidor de abrillantador
- 6** Distribuidor de detergente

- 7** Cesto de talheres
- 8** Cesto inferior
- 9** Braço aspersor superior
- 10** Cesto superior



Painel de controlo





- 1** Botão ligar/desligar/Botão de Reset
- 2** Botão de Início Diferido
- 3** Indicadores
- 4** Botões de programa







- 5** Power Clean Botão
- 6** AUTO Botão de programa

Indicadores

| Indicador | Do ciclo |
|--|---|
|  | Indicador de abrilhantador. Está aceso quando o dispensador de abrilhantador necessita de ser reabastecido. |
|  | Indicador de falta de sal. Está aceso quando o recipiente do sal necessita de ser reabastecido. |

| Indicador | Do ciclo |
|---|--|
|  | Indicador Machine Care. Está aceso quando a aparelho necessita de limpeza interna com o programa Machine Care. |
|  | Indicador da fase de secagem. Está aceso quando está selecionado o programa com fase de secagem. Pisca quando a fase de secagem está em curso. |

Visão geral de programas

| Programa | Carga de máquina de lavar loiça | Nível de sujidade | Temperatura (°C) | Tempo (min) | Opções | AutoOpen |
|--|--|------------------------------------|------------------|-------------|---|----------|
|  Quick 30' | Loiça, talheres | Sujidade recente | 50 | 30 |  | ✓ |
|  Rinse & Hold | Todos os tipos de carga | Todos os níveis de sujidade | Água fria | 15 | ✗ | ✗ |
|  90 Minutes | Loiça, talheres, tachos, panelas | Sujidade normal, ligeiramente seca | 60 | 90 |  | ✓ |
| ECO 1) | Loiça, talheres, tachos, panelas | Sujidade normal, ligeiramente seca | 50 | 227 |  | ✓ |
| AUTO | Loiça, talheres, tachos, panelas | Todas | 50 - 60 | 120 - 170 | ✗ | ✓ |
| Machine Care | Para limpar o interior do aparelho. Consulte "Limpeza e Manutenção". | | 70 | 60 | ✗ | ✓ |

1) Com este programa, terá os consumos de água e energia mais eficientes para loiça e talheres com sujidade normal. Este é o programa padrão para institutos de testes. Este programa é utilizado para avaliar a conformidade com o Regulamento de Ecodesign da Comissão (UE) 2019/2022.

Opções

Pode regular a seleção de programa para as suas necessidades ativando as opções.

Power Clean

 Power Clean melhora os resultados de lavagem do programa selecionado. A opção

aumenta a temperatura e a duração da lavagem.

Definições de base

| Número | Definições | Valor de definição | Dureza da água | |
|--------|--------------------------------------|--------------------|----------------|---------------------|
| | | | mmol/l | Graus alemães (°dH) |
| 1 | Amaciador de água | 10 | 8.4 - 9.0 | 47 - 50 |
| | | 9 | 7.6 - 8.3 | 43 - 46 |
| | | 8 | 6.5 - 7.5 | 37 - 42 |
| | | 7 | 5.1 - 6.4 | 29 - 36 |
| | | 6 | 4.0 - 5.0 | 23 - 28 |
| | | 5 1) | 3.3 - 3.9 | 19 - 22 |
| | | 4 | 2.6 - 3.2 | 15 - 18 |
| | | 3 | 1.9 - 2.5 | 11 - 14 |
| | | 2 | 0.7 - 1.8 | 4 - 10 |
| | 1 2) | <0.7 | <4 | |
| 2 | Indicação de falta de abri-lhantador | Ligado/Desligado | | |
| 3 | Indicador de fim | Ligado/Desligado | | |
| 4 | Abrir porta au-to. | Ligado/Desligado | | |
| 5 | Sons "teclado" | Ligado/Desligado | | |

1) Definição de fábrica.

2) Não utilize sal neste nível.

Quando o aparelho estiver no modo de definições, os indicadores no painel de controlo representam as definições disponíveis. Para cada definição, pisca um indicador dedicado:

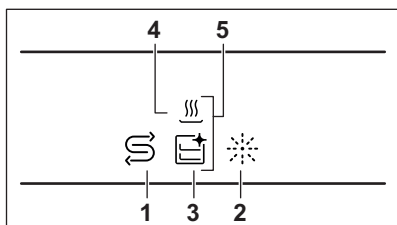

Modo de configuração

| Botão | Do ciclo |
|-------|---|
| | Botão Anterior. Prima para alternar entre as definições básicas e para alterar os seus valores. |
| | Botão OK. Prima para entrar na definição selecionada e para confirmar a alteração do seu valor. |

| Botão | Do ciclo |
|-------|---|
| | Botão Seguinte. Prima para alternar entre as definições básicas e para alterar os seus valores. |

Como alterar uma definição

1. Para entrar no modo de definição, prima simultaneamente e **ECO** durante cerca de 3 segundos.

- A luz relacionada com e o indicador ficam intermitentes.
- Os indicadores , e estão acesos.
- As luzes relacionadas com os botões de programa acendem-se.

2. Prima **Anterior** ou **Seguinte** até que o indicador correspondente à definição selecionada fique intermitente.

A luz relacionada com indica o valor da definição atual:

- Para as definições com dois valores (on e off), a luz acende-se (= a definição está ligada) ou apaga-se (= a definição está desligada).
- Para definições com valores (níveis) múltiplos, a luz pisca. O número de intermitências indica o nível da definição atual (por exemplo, 5 intermitências + pausa + 5 intermitências... = nível 5).

3. Prima **OK** para introduzir a definição.

- O indicador relacionado com a definição acende-se.
- Os outros indicadores apagam-se.
- A luz relacionada com indica o valor da definição atual.

4. Prima **Anterior** ou **Seguinte** para alterar o valor.

5. Prima **OK** para confirmar o valor da definição.

- O novo valor de definição é guardado.
- O aparelho volta à lista de definições básicas.

6. Prima simultaneamente  30' e ECO durante cerca de 3 segundos para sair do modo de definição.

O aparelho muda para a seleção de programa.

AutoOpen

AutoOpen melhora a secagem e reduz o consumo de energia. A porta do aparelho abre automaticamente durante a fase de secagem e permanece entreaberta.

-  **CUIDADO!** Não tente fechar a porta do aparelho durante os primeiros 2 minutos após a abertura automática. Isso pode danificar o aparelho.

-  **CUIDADO!** Se crianças, animais de estimação ou pessoas com deficiência tiverem acesso ao aparelho, desative AutoOpen. A abertura automática da porta pode representar um perigo e expor possíveis perigos no interior do aparelho (tais como facas, objetos afiados, produtos químicos).

Antes da primeira utilização

Certifique-se de que o nível atual do descalcificador de água está ajustado para a dureza da água fornecida.

Utilize o programa Quick 30' para remover resíduos do processo de fabrico.

1. Coloque 1 litro de água no depósito de sal.
2. Coloque 1 kg de sal no depósito de sal. Utilize apenas sal grosso especial para máquinas de lavar loiça.
3. Encha o distribuidor de abrillantador.
4. Abra a torneira da água.
5. Selecione o programa Quick 30' e feche a porta para o iniciar. Não use detergente e não coloque pratos nos cestos.

-  **CUIDADO!** É possível que saia água e sal do depósito de sal quando estiver a enchê-lo. Após encher o depósito de sal, inicie imediatamente um programa para evitar corrosão.

-  Se não utilizar o aparelho, feche a torneira de água.

Resolução de problemas

Se tiver um problema com o seu aparelho, consulte o capítulo "Resolução de

problemas" na versão completa do Manual do Utilizador disponível em: www.ikea.com.

Informação técnica

| | |
|-----------------|---|
| Tipo de produto | Máquina de lavar loiça totalmente encastrável |
|-----------------|---|

| | | |
|-----------|--------------------------------------|-----------------------|
| Dimensões | Largura / Altura / Profundidade (mm) | 596 / 818 - 898 / 550 |
|-----------|--------------------------------------|-----------------------|

| | | |
|---------------------------------|-----------------------------|-----------------------|
| Ligação elétrica 1) | Tensão (V) | 220 - 240 |
| | Frequência (Hz) | 50 |
| Pressão do fornecimento de água | Bar mín./máx. (MPa) | 0.5 (0.05) / 10 (1.0) |
| Fornecimento de água | Água fria ou água quente 2) | máx. 60 °C |
| Capacidade | Definições de colocação | 13 |

1) Consulte a placa de classificação para conhecer os outros valores.

2) Se a água quente for proveniente de fontes de energias renováveis (p. ex., painéis solares, energia eólica), utilize o fornecimento de água quente para diminuir o consumo de energia.

Link para a base de dados de EU EPREL

O código QR no rótulo energético fornecido com o aparelho disponibiliza um link da web para o registo deste aparelho na base de dados da EU EPREL. Mantenha a etiqueta de energia para consulta juntamente com o manual do utilizador e todos os outros documentos disponibilizados com este aparelho.

É possível encontrar informação relacionada com o desempenho do produto na base de dados de EU EPREL utilizando o link <https://eprel.ec.europa.eu> e o nome do modelo e número do produto que pode encontrar na placa de características do aparelho. Consulte o capítulo “Descrição do produto”.

Para informação mais detalhada sobre a etiqueta de energia, visite www.theenergylabel.eu.

Descripción del producto

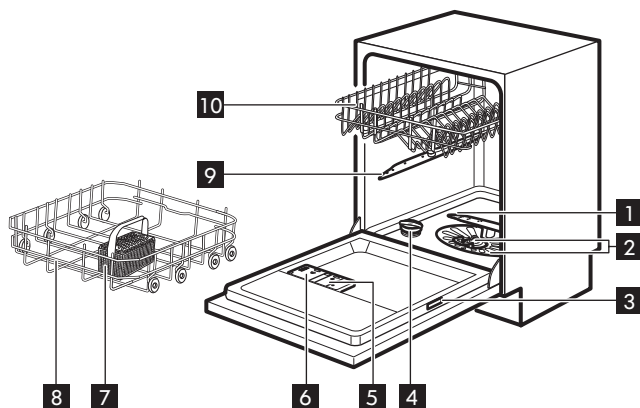



- | | |
|--|------------------------------------|
| 1 Brazo aspersor inferior | 7 Cesto de cubiertos |
| 2 Filtros | 8 Cesto inferior |
| 3 Placa de características técnicas | 9 Brazo aspersor intermedio |
| 4 Depósito de sal | 10 Cesto superior |
| 5 Dosificador de abrillantador | |
| 6 Dosificador de detergente | |



Panel de mandos









- | | |
|---|---------------------------------|
| 1 Botón de encendido/apagado / Botón de reinicio | 4 Botones de programa |
| 2 Botón de inicio diferido | 5 Botón Power Clean |
| 3 Indicadores | 6 Botón de programa AUTO |

Indicadores

| Indicador | Descripción |
|--|--|
|  | Indicador de abrillantador. Se enciende cuando hay que rellenar el dosificador de abrillantador. |
|  | Indicador de sal. Se enciende cuando hay que rellenar el depósito de sal. |

| Indicador | Descripción |
|---|--|
|  | Indicador Machine Care. Se enciende cuando el aparato necesita una limpieza interna con el programa Machine Care. |
|  | Indicador de fase de secado. Se activa cuando se selecciona un programa con la fase de secado. Parpadea durante la fase de secado. |

Resumen de los programas

| Programa | Carga del lavavajillas | Grado de suciedad | Temperatura (°C) | Hora (m) | Opciones | AutoOpen |
|--|---|--|------------------|-----------|---|----------|
|  Quick 30' | Vajilla, cubertería | Suciedad reciente | 50 | 30 |  | ✓ |
|  Rinse & Hold | Todo tipo de carga | Todos los grados de suciedad | Agua fría | 15 | X | X |
|  90 Minutes | Vajilla, cubiertos, ollas y sartenes | Residuos de comida normales, ligeramente secos | 60 | 90 |  | ✓ |
| ECO 1) | Vajilla, cubiertos, ollas y sartenes | Residuos de comida normales, ligeramente secos | 50 | 227 |  | ✓ |
| AUTO | Vajilla, cubiertos, ollas y sartenes | Todo | 50 - 60 | 120 - 170 | X | ✓ |
| Machine Care | Limpieza del interior del aparato. Consulte "Limpieza y mantenimiento". | | 70 | 60 | X | ✓ |

1) Este programa ofrece el uso más eficaz en cuanto al consumo de agua y energía para vajillas y cubiertos con suciedad normal. Este es el programa estándar para institutos de pruebas. Este programa se utiliza para evaluar el cumplimiento del Reglamento de la Comisión sobre ecodiseño (UE) 2019/2022.

Opciones

Puede ajustar la selección de programas a sus necesidades activando opciones.

Power Clean

 Power Clean mejora los resultados de lavado del programa seleccionado. Esta

opción aumenta la temperatura y la duración del lavado.

Ajustes básicos

| Número | Ajustes | Valor de ajuste | Dureza del agua | |
|--------|--------------------------------|-------------------|-----------------|-----------------------|
| | | | mmol/l | Grados alemanes (°dH) |
| 1 | Descalcificador de agua | 10 | 8.4 - 9.0 | 47 - 50 |
| | | 9 | 7.6 - 8.3 | 43 - 46 |
| | | 8 | 6.5 - 7.5 | 37 - 42 |
| | | 7 | 5.1 - 6.4 | 29 - 36 |
| | | 6 | 4.0 - 5.0 | 23 - 28 |
| | | 5 1) | 3.3 - 3.9 | 19 - 22 |
| | | 4 | 2.6 - 3.2 | 15 - 18 |
| | | 3 | 1.9 - 2.5 | 11 - 14 |
| | | 2 | 0.7 - 1.8 | 4 - 10 |
| | | 1 2) | <0.7 | <4 |
| 2 | Notificación del abrillantador | Encendido/Apagado | | |
| 3 | Sonido de fin | Encendido/Apagado | | |
| 4 | Apertura puerta auto. | Encendido/Apagado | | |
| 5 | Tono de teclas | Encendido/Apagado | | |

1) Ajustes de fábrica.

2) No utilice sal en este nivel.

Cuando el aparato está en el modo de ajuste, los indicadores del panel de mandos representan los ajustes disponibles. Para cada ajuste, un indicador dedicado del parpadea:

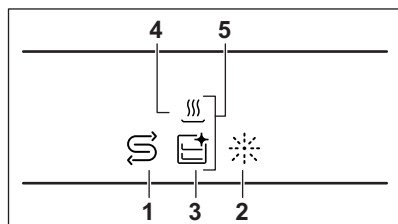

Modo de ajuste

| Tecla | Descripción |
|-------|---|
| 1h | Botón Anterior. Púlsalo para cambiar entre los ajustes básicos y para modificar su valor. |
| | Botón ACEPTAR. Púlsalo para introducir el ajuste seleccionado y confirmar el cambio de valor. |
| | Botón Siguiente. Púlsalo para cambiar entre los ajustes básicos y para modificar su valor. |

Cómo cambiar un ajuste

- Mantén pulsados simultáneamente 30' y **ECO** durante unos 3 segundos para acceder al modo de ajuste.
 - La luz correspondiente a 3h y el indicador parpadean.
 - Los indicadores , , y están encendidos.
 - Las luces relacionadas con los botones de programa están encendidas.
- Pulse **Anterior** o **Siguiente** hasta que parpadee el indicador correspondiente al ajuste seleccionado.

La luz correspondiente a 3h muestra el ajuste actual:

- Para las configuraciones con dos valores (activado y desactivado), la luz está encendida (= la configuración está activada) o desactivada (= la configuración está desactivada).
 - Para los ajustes con múltiples valores (niveles), la luz parpadea. El número de parpadeos indica el nivel de ajuste actual (p. ej. 5 parpadeos + pausa + 5 parpadeos... = nivel 5).
- Pulsa **ACEPTAR** para introducir el ajuste.
 - El indicador correspondiente al ajuste está encendido.
 - Los otros indicadores están apagados.
 - La luz correspondiente a 3h muestra el ajuste actual.
 - Pulsa **Anterior** o **Siguiente** para cambiar el valor.
 - Pulsa **ACEPTAR** para confirmar el valor de ajuste.
 - El nuevo valor de ajuste se ha guardado.
 - El aparato vuelve a la lista de ajustes básica.
 - Mantén pulsados simultáneamente 30' y **ECO** durante unos 3 segundos para salir del modo de ajuste.

El aparato cambia a la selección de programas.

AutoOpen

AutoOpen mejora el resultado de secado con menos consumo de energía. La puerta del aparato se abre automáticamente durante la fase de secado y permanece entreabierta.

⚠ PRECAUCIÓN! No intente cerrar la puerta del aparato durante 2 minutos después de la apertura automática. Podría dañar el aparato.

⚠ PRECAUCIÓN! Si los niños, mascotas o personas con discapacidades tienen acceso al aparato, desactiva AutoOpen. La apertura automática de la puerta puede suponer un peligro y quedar también expuestos posibles peligros dentro del aparato (como cuchillos, objetos afilados o productos químicos).

Antes del primer uso

Asegúrese de que el ajuste actual del descalcificador de agua se adecúa a la dureza del agua utilizada.

Use el programa Quick 30' para eliminar los residuos del proceso de fabricación.

1. Vierta 1 litro de agua en el depósito de sal.
2. Ponga 1 kg de sal en el depósito de sal. Utilice solo sal gruesa diseñada para lavavajillas.
3. Llenado del dosificador de abrillantador.
4. Abra el grifo.
5. Seleccione el programa Quick 30' y cierre la puerta del lavavajillas para iniciarlo.

No utilice detergente ni cargue platos en los costos.

⚠ PRECAUCIÓN! El agua y la sal pueden salirse del depósito de sal cuando lo llena. Después de llenar el depósito de sal, inicie inmediatamente un programa para evitar la corrosión.

i Si no utiliza el aparato, cierre el grifo de agua.

Solución de problemas

Si tiene algún problema con el aparato, consulte el capítulo "Solución de problemas"

en la versión completa del manual del usuario disponible en: www.ikea.com.

Información técnica

| | | |
|----------------------------------|-----------------------------------|-----------------------|
| Tipo de producto | Lavavajillas totalmente integrado | |
| Dimensiones | Ancho / alto / fondo (mm) | 596 / 818 - 898 / 550 |
| Conexión eléctrica ¹⁾ | Tensión (V) | 220 - 240 |
| | Frecuencia (Hz) | 50 |

| | | |
|--------------------------------|------------------------------------|-----------------------|
| Presión del suministro de agua | Min. / máx. bares (Mpa) | 0.5 (0.05) / 10 (1.0) |
| Suministro de agua | Agua fría o caliente ²⁾ | máx. 60°C |

| | | |
|-----------|-----------------------|----|
| Capacidad | Coloque los cubiertos | 13 |
|-----------|-----------------------|----|

1) Consulte la placa de datos técnicos para otros valores.

2) Si el agua caliente procede de una fuente de energía alternativa (por ejemplo, paneles solares o energía eólica), utilice la toma de agua caliente para reducir el consumo de energía.

Enlace a la base de datos EPREL de la UE

El código QR de la etiqueta energética suministrada con el aparato proporciona un enlace web para el registro de este aparato en la base de datos de EU EPREL. Guarde la etiqueta de energía como referencia junto con el manual de usuario y todos los demás documentos que se proporcionan con este aparato.

Es posible encontrar información relacionada con el rendimiento del producto en la base de datos EPREL de la UE utilizando el enlace <https://eprel.ec.europa.eu> y el nombre del modelo y el número de producto que se encuentra en la placa de características del aparato. Consulte el capítulo "Descripción del producto".

Para obtener información más detallada sobre la etiqueta energética, visite www.theenergylabel.eu.

Productbeschrijving

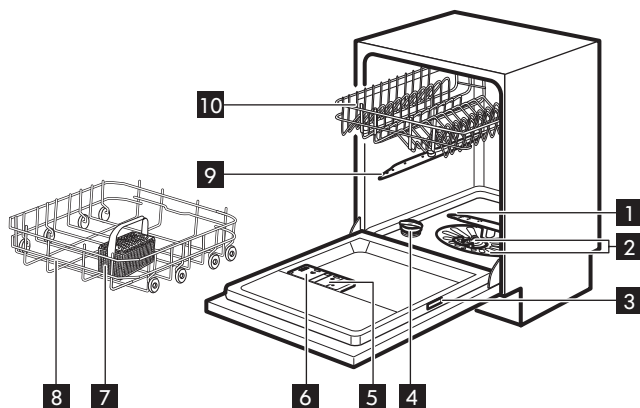

- 1 Onderste sproeiarm
- 2 Filters
- 3 Typeplaatje
- 4 Zoutreservoir
- 5 Glansmiddeldoseerbakje
- 6 Afwasmiddeldoseerbakje

- 7 Bestekmand
- 8 Onderste korf
- 9 Bovenste sproeiarm
- 10 Bovenste korf

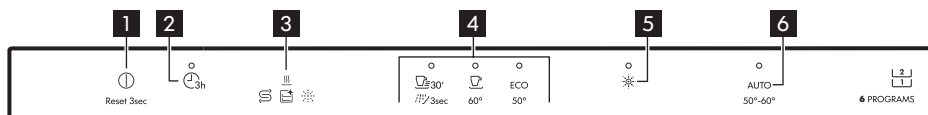

Bedieningspaneel





- 1 Aan-/uittoets/Resettoets
- 2 Toets uitgestelde start
- 3 Indicatielampjes
- 4 Programmatoetsen







- 5 Power Clean toets
- 6 AUTO programmatoets

Indicatielampjes

| Indicatie-lampje | Beschrijving |
|--|---|
|  | Indicatielampje glansspoelmiddel. Dit is aan als het glansspoelmiddeldoseerbakje bijge- vuld dient te worden. |
|  | Indicatielampje zout. Dit is aan als het zout- reservoir bijge- vuld dient te worden. |

| Indicatie- lampje | Beschrijving |
|---|---|
|  | Indicatielampje Machine Care. Dit is aan als het apparaat interne reiniging nodig heeft met het Machine Care-programma. |
|  | Controlelampje droogfase. Dit is aan als een programma met droogfase is gekozen. Het gaat knipperen wanneer de droogfase loopt. |

Programmaoverzicht

| Programma | Lading vaatwas- ser | Mate van bevu- ling | Temperatuur (°C) | Tijd (min) | Opties | AutoOpen |
|--|---|---------------------------------|------------------|------------|---|----------|
|  Quick 30' | Serviesgoed, be- stek | Recente bevu- ling | 50 | 30 |  | ✓ |
|  Rinse & Hold | Alle soorten la- ding | Alle vuilgraden | Koud water | 15 | ✗ | ✗ |
|  90 Minutes | Serviesgoed, be- stek, potten, pannen | Normaal, licht gedroogd op vuil | 60 | 90 |  | ✓ |
| ECO 1) | Serviesgoed, be- stek, potten, pannen | Normaal, licht gedroogd op vuil | 50 | 227 |  | ✓ |
| AUTO | Serviesgoed, be- stek, potten, pannen | Alles | 50 - 60 | 120 - 170 | ✗ | ✓ |
| Machine Care | Voor het reinigen van de binnen- kant van het apparaat. Zie "Reini- ging en onderhoud". | | 70 | 60 | ✗ | ✓ |

1) Dit programma heeft het meest efficiënte water- en energieverbruik voor normaal vervuild serviesgoed en be- stek. Dit is het standaardprogramma voor testinstituten. Dit programma wordt gebruikt voor de beoordeling van de naleving van Verordening (EU) 2019/2022 van de Commissie inzake ecologisch ontwerp.

Opties

U kunt de programmakeuze aanpassen aan uw behoeften door opties te activeren.

Power Clean

 Power Clean verbetert de vaatwasresultaten van het geselecteerde

programma. De optie verhoogt de wastemperatuur en verlengt de duur.

Basisinstellingen

| Aantal | Instellingen | Waarde instellen | Waterhardheid | |
|--------|--|------------------|---------------|-----------------------|
| | | | mmol/l | Duitse hardheid (°dH) |
| 1 | Waterontharder | 10 | 8.4 - 9.0 | 47 - 50 |
| | | 9 | 7.6 - 8.3 | 43 - 46 |
| | | 8 | 6.5 - 7.5 | 37 - 42 |
| | | 7 | 5.1 - 6.4 | 29 - 36 |
| | | 6 | 4.0 - 5.0 | 23 - 28 |
| | | 5 1) | 3.3 - 3.9 | 19 - 22 |
| | | 4 | 2.6 - 3.2 | 15 - 18 |
| | | 3 | 1.9 - 2.5 | 11 - 14 |
| | | 2 | 0.7 - 1.8 | 4 - 10 |
| | 1 2) | <0.7 | <4 | |
| 2 | Melding dat het glansmiddelreservoir leeg is | Aan/uit | | |
| 3 | Geluid stoppen | Aan/uit | | |
| 4 | Aut. deuropening | Aan/uit | | |
| 5 | Toetstonen | Aan/uit | | |



1) Fabrieksinstelling.

2) Gebruik geen zout op dit niveau.

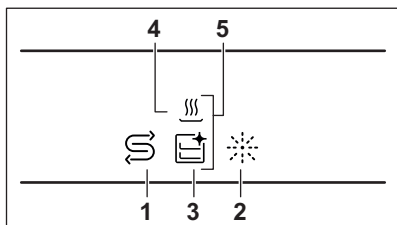
Als het apparaat in de instellingenstand staat, vertegenwoordigen de indicatielampjes op het bedieningspaneel de beschikbare instellingen. Voor iedere instelling knippert een aangewezen indicatielampje:









Instellingsmodus

| Toets | Beschrijving |
|---|---|
|  1h | Vorige-toets. Druk om te schakelen tussen de basisinstellingen en om hun waarde te wijzigen. |
|  | OK-toets. Druk om in de gekozen instelling te gaan en de gewijzigde waarde hiervan te bevestigen. |

| Toets | Beschrijving |
|---|--|
|  | Volgende-toets. Druk om te schakelen tussen de basisinstellingen en om hun waarde te wijzigen. |

Een instelling wijzigen

- Om de instellingenmodus in te gaan, druk je tegelijkertijd op  30' en **ECO** en houd je die ongeveer 3 seconden vast.
 - Het licht dat in verband staat met  en het indicatielampje  knipperen.
 - De lampjes  en  zijn aan.
 - De lampjes van de programmaknoppen zijn aan.
- Druk op **Vorige** of **Volgende** totdat het indicatielampje van de geselecteerde instelling knippert.

Het licht dat in verband staat met  geeft de huidige instelwaarde aan:

- Voor de instellingen met twee waarden (aan en uit) is het licht ofwel aan (= de instelling staat aan) of uit (= de instelling staat uit).
 - Voor de instellingen met meerdere waarden (niveaus) knippert het licht. Het aantal knipperingen geeft de huidige instelwaarde aan (bijv. 5 knipperingen + pauze + 5 knipperingen... = niveau 5).
- Druk op **OK** om de instelling te bevestigen.
 - Het indicatielampje dat verband houdt met de instelling gaat aan.
 - De andere indicatielampjes gaan uit.
 - Het licht dat in verband staat met  geeft de huidige instelwaarde aan:
 - Druk op **Vorige** of **Volgende** om de waarde te veranderen.
 - Druk op **OK** om de instellingswaarde te bevestigen.
 - De nieuwe instellingswaarde wordt opgeslagen.
 - Het apparaat keert terug naar de basisinstellingenlijst.

6. Druk tegelijkertijd op  en **ECO** en houd ze ongeveer 3 seconden ingedrukt om de instellingsmodus te verlaten.

Het apparaat schakelt over naar de programmakeuze.

AutoOpen

AutoOpen biedt goede droogresultaten met minder energieverbruik. Tijdens de droogfase opent de deur van het apparaat automatisch en blijft deze op een kier staan.

-  **Let op!** Probeer de deur van het apparaat niet binnen twee minuten na automatisch openen te sluiten. Dit kan het apparaat beschadigen.

-  **Let op!** Als kinderen, huisdieren of mensen met een handicap toegang hebben tot het apparaat, schakel je AutoOpen uit. Het automatisch openen van de deur kan een gevaar vormen en mogelijke gevaren in het apparaat blootstellen (zoals messen, scherpe voorwerpen, chemicaliën).

Voorafgaand aan het eerste gebruik

Zorg ervoor dat het stroomniveau van de waterontharder is aangepast aan de hardheid van de watertoevoer.

Gebruik het programma Quick 30' om resten uit het productieproces te verwijderen.

1. Giet 1 liter water in het zoutreservoir.
2. Doe 1 kg zout in het zoutreservoir. Gebruik uitsluitend grof zout dat voor vaatwassers is gemaakt.
3. Vul het glansmiddeldoseerbakje.
4. Open de waterkraan.
5. Selecteer het programma Quick 30' en sluit de deur van de vaatwasser om deze

te starten. Gebruik geen afwasmiddel en plaats geen vaat in de korven.

-  **Let op!** Water en zout kunnen uit het zoutreservoir stromen als u het bijvult. Start na het bijvullen van het zoutreservoir onmiddellijk een programma om corrosie te voorkomen.

-  Als je het apparaat niet gebruikt, sluit dan de waterkraan.

Probleemoplossing

Als u op een probleem met uw apparaat stuit, raadpleeg dan het hoofdstuk "Probleemoplossing" in de volledige versie

van de gebruikershandleiding, beschikbaar op: www.ikea.com.

Technische informatie

| | | |
|-------------|-----------------------------------|-----------------------|
| Producttype | Volledig geïntegreerde vaatwasser | |
| Afmetingen | Breedte / hoogte / diepte (mm) | 596 / 818 - 898 / 550 |

| | | |
|---------------------------------------|-----------------|-----------|
| Elektrische aansluiting ¹⁾ | Spanning (V) | 220 - 240 |
| | Frequentie (Hz) | 50 |

| | | |
|------------------|-----------------------------|-----------------------|
| Watertoevoerdruk | Min. / max. bar (MPa) | 0.5 (0.05) / 10 (1.0) |
| Watertoevoer | Koud water of warm water 2) | max. 60°C |
| Capaciteit | Plaatsinstellingen | 13 |

1) Zie het typeplaatje voor andere waarden.

2) Als het hete water door een alternatieve energiebron wordt geproduceerd (bijv. zonnepanelen, eolische energie), gebruik dan de heatwatervoorziening om het energieverbruik te verminderen.

Link naar de EU-EPREL-databank

De QR-code op het energielabel dat bij het apparaat wordt geleverd, biedt een weblink naar de registratie van dit apparaat in de EU-EPREL-database. Bewaar het energielabel ter referentie samen met de gebruikershandleiding en alle andere documenten die bij dit apparaat worden geleverd.

Het is ook mogelijk om informatie gerelateerd aan de prestaties van het product in de EU-EPREL-databank te vinden via de link <https://eprel.ec.europa.eu> en de modelnaam en het productnummer kunt u vinden op het typeplaatje van het apparaat. Zie het hoofdstuk 'Productbeschrijving'.

Kijk voor meer informatie over het energielabel op www.theenergylabel.eu

Produktbeskrivelse

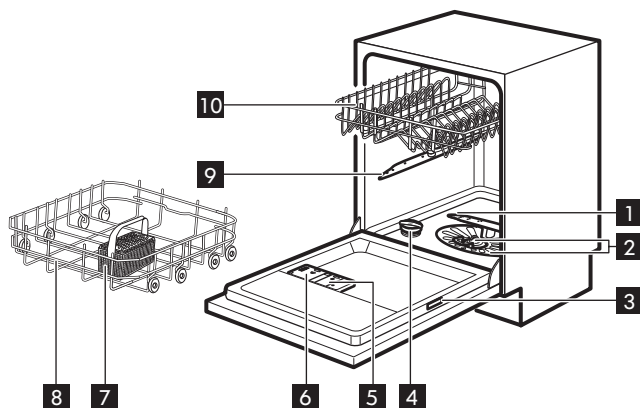



- | | |
|---------------------------------------|---------------------------|
| 1 Nederste spulearm | 7 Bestikkurv |
| 2 Filtre | 8 Nederste kurv |
| 3 Typeskilt | 9 Øverste spulearm |
| 4 Saltbeholder | 10 Øverste kurv |
| 5 Kammer til afspændingsmiddel | |
| 6 Opvaskemiddeldispenser | |

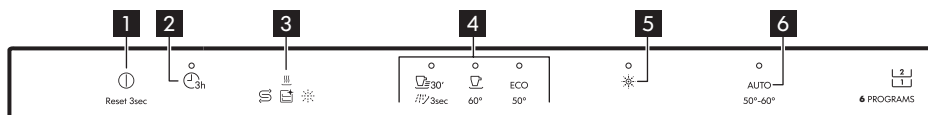

Kontrolpanel









- | | |
|---|---------------------------|
| 1 Tænd-/sluk-knap/Nulstillingsknap | 5 Power Clean-knap |
| 2 Senere start-knap | 6 AUTO-programknap |
| 3 Lamper | |
| 4 Programknap | |

Kontrollamper

| Kontrollampe | Beskrivelse |
|--|--|
|  | Lampe for afspændingsmiddel. Lyser, når kammeret til afspændingsmiddel skal genfyldes. |
|  | Kontrollampe for salt. Er tændt, når saltbeholderen skal genfyldes. |

| Kontrollampe | Beskrivelse |
|---|---|
|  | Machine Care-lampe Den er tændt, når apparatet har brug for indvendig rengøring med Machine Care-programmet. |
|  | Kontrollampe for tørrefase. Den er tændt, når du vælger et program med tørrefasen. Den blinker, når tørrefasen er i gang. |

Programoversigt

| Program | Fyldning af opvaskemaskine | Graden af snavs | Temperatur (°C) | Tid (min.) | Valgmuligheder | AutoOpen |
|--|---|--------------------------------|-----------------|------------|---|----------|
|  Quick 30' | Service, bestik | Frisk snavset | 50 | 30 |  | ✓ |
|  Rinse & Hold | Alle typer opvask | Alle grader af snavs | Koldt vand | 15 | ✗ | ✗ |
|  90 Minutes | Service, bestik, gryder, pander | Normalt, let indtørret snavset | 60 | 90 |  | ✓ |
| ECO 1) | Service, bestik, gryder, pander | Normalt, let indtørret snavset | 50 | 227 |  | ✓ |
| AUTO | Service, bestik, gryder, pander | Alt | 50 - 60 | 120 - 170 | ✗ | ✓ |
| Machine Care | Rengøring af apparatet indvendigt. Se "Rengøring og vedligeholdelse". | | 70 | 60 | ✗ | ✓ |

1) Dette program tilbyder det mest effektive vand- og energiforbrug til service og bestik med normalt snavs. Dette er standardprogrammet til testgennemførsler. Dette program bruges til at vurdere overholdelse af forordningen om miljøvenligt design (EU) 2019/2022.

Tilvalg

Du kan justere programvalget til dine behov ved at aktivere tilvalg.

Power Clean

 Power Clean forbedrer opvaskeresultaterne for det valgte program.

Tilvalget øger opvasketemperaturen og -varigheden.

Grundindstillinger

| Nummer | Indstillinger | Indstillingsværdi | Vandets hårdhed | |
|--------|---|-------------------|-----------------|--------------------|
| | | | mmol/l | Tyske grader (°dH) |
| 1 | Blødgøringslæg | 10 | 8.4 - 9.0 | 47 - 50 |
| | | 9 | 7.6 - 8.3 | 43 - 46 |
| | | 8 | 6.5 - 7.5 | 37 - 42 |
| | | 7 | 5.1 - 6.4 | 29 - 36 |
| | | 6 | 4.0 - 5.0 | 23 - 28 |
| | | 5 1) | 3.3 - 3.9 | 19 - 22 |
| | | 4 | 2.6 - 3.2 | 15 - 18 |
| | | 3 | 1.9 - 2.5 | 11 - 14 |
| | | 2 | 0.7 - 1.8 | 4 - 10 |
| | | 1 2) | <0.7 | <4 |
| 2 | Meddelelse om manglende afspændingsmiddel | Tænd / sluk | | |
| 3 | Slutlyd | Tænd / sluk | | |
| 4 | Automatisk døråbner | Tænd / sluk | | |
| 5 | Panel signaler | Tænd / sluk | | |



1) Fabrikindsstilling.

2) Brug ikke salt på dette niveau.

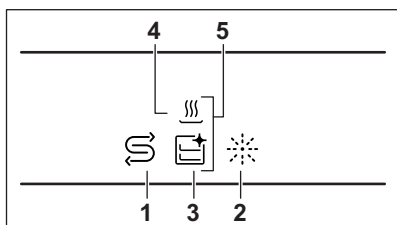







Når apparatet er i indstillingstilstand, repræsenterer kontrolpanelets lamper tilgængelige indstillinger. For hver indstilling blinker en særlig lampe:



Indstillingstilstand

| Knap | Beskrivelse |
|---|--|
|  1h | Forrige-knap. Tryk for at skifte mellem grundindstillingerne og for at ændre deres værdi. |
|  | OK-knap. Tryk for at gå ind i den valgte indstilling og for at bekræfte ændringen af dens værdi. |
|  | Næste-knap. Tryk for at skifte mellem grundindstillingerne og for at ændre deres værdi. |

Sådan ændres en indstilling

- Tryk på  30' og **ECO** og hold dem nede samtidigt i ca. 3 sekunder for at gå ind i indstillingstilstand.
 - Lampen relateret til  og lampen  blinker.
 - Lamperne ,  og  er tændt.
 - Lampen relateret til programknapperne er tændt.
- Tryk på **Forrige** eller **Næste**, indtil lampen for den valgte indstilling blinker. Lampen relateret til  indikerer den aktuelle indstillingsværdi:
 - For indstillinger med to værdier (tændt og slukket), er lampen enten tændt (= indstillingen er tændt) eller slukket (= indstillingen er slukket).
 - For indstillinger med flere værdier (niveauer) blinker lampen. Antallet af blink angiver den aktuelle indstillingsværdi (f.eks. 5 blink + pause + 5 blink osv. = trin 5).
- Tryk på **OK** for at åbne indstillingen.
 - Lampen relateret til indstillingen tændes.
 - De andre lamper slukkes.
 - Lampen relateret til  indikerer den aktuelle indstillingsværdi.
- Tryk på **Forrige** eller **Næste** for at ændre værdien.
- Tryk på **OK** for at bekræfte indstillingsværdien.
 - Den nye indstillingsværdi gemmes.
 - Maskinen vender tilbage til listen over grundindstillinger.
- Tryk på  30' og **ECO** og hold dem nede samtidigt i ca. 3 sekunder for at forlade indstillingstilstand. Apparatet skifter til programvalget.

AutoOpen

AutoOpen forbedrer tørreresultaterne med mindre energiforbrug. Lågen til maskinen

åbnes automatisk under tørrefasen og forbliver på klem.

- ⚠ Forsigtig!** Forsøg ikke at lukke opvaskemaskinens låge inden for 2 minutter efter automatisk åbning. Det kan beskadige maskinen.

- ⚠ Forsigtig!** Hvis børn, kæledyr eller personer med handicap har adgang til apparatet, skal du deaktivere AutoOpen. Den automatiske åbning af lågen kan udgøre en fare og udsætte eventuelle farer i apparatet (f.eks. knive, skarpe genstande, kemikalier).

Før brug første gang

Sørg for, at blødgøringsanlæggets strømniveau passer til vandforsyningens hårdhed.

Brug programmet Quick 30' til at fjerne rester fra fremstillingsprocessen.

1. Hæld 1 liter vand i saltbeholderen.
2. Hæld 1 kg salt i saltbeholderen.
Brug groft salt, der kun er beregnet til opvaskemaskiner.
3. Påfyldning af kammeret til afspændingsmiddel
4. Åbn vandhanen.
5. Vælg programmet, Quick 30' og luk opvaskemaskinens låge for at starte den.

Brug ikke opvaskemiddel, og fyld ikke service i kurvene.

- ⚠ Forsigtig!** Der kan løbe vand og salt ud af saltbeholderen, når du fylder den. Start øjeblikkeligt et program, efter du har fyldt saltbeholderen, for at forhindre korrosion.

- i** Hvis du ikke bruger apparatet, skal du lukke for vandhanen.

Fejlfinding

Hvis du støder på et problem med dit apparat, kan du se kapitlet "Fejlfinding" i den

fulde version af brugervejledningen, som findes på: www.ikea.com.

Tekniske oplysninger

| Produkttype | Fuldt integreret opvaskemaskine | |
|------------------------------|---|-----------------------|
| Mål | Bredde/højde/dybde (mm) | 596 / 818 - 898 / 550 |
| El-forbindelse ¹⁾ | Spænding (V) | 220 - 240 |
| | Frekvens (Hz) | 50 |
| Vandforsyningstryk | Min./maks. bar (MPa) | 0.5 (0.05) / 10 (1.0) |
| Vandforsyning | Koldt vand eller varmt vand ²⁾ | maks. 60°C |

| Kapacitet | Sæt indstillinger | 13 |
|-----------|-------------------|----|
|-----------|-------------------|----|

- 1) Se typeskiltet for andre værdier.
2) Hvis det varme vand leveres af alternativ energikilde (f.eks. solfangere, vindenergi), bruges tilslutning til varmt vand for at spare på energien.

Link til EU EPREL-databasen

QR-koden på energimærket forsynet med apparatet indeholder et weblink til registreringen af dette apparat i EU EPREL-databasen. Opbevar energimærket til

reference sammen med brugervejledningen og alle andre dokumenter, der følger med dette apparat.

Det er muligt at finde information relateret til produktets ydelse i EU EPREL-databasen ved hjælp af linket <https://eprel.ec.europa.eu> og modelnavnet og produktnummeret, som du kan finde på apparatets typeskilt. Se kapitlet "Produktbeskrivelse".

Få mere detaljeret information om energimærket på www.theenergylabel.eu.

Produktbeskrivelse

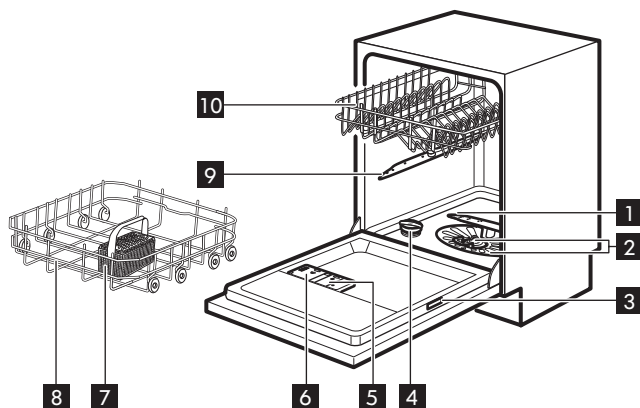



- | | |
|--------------------------------|------------------------|
| 1 Nedre spylearm | 7 Bestikkurv |
| 2 Filtre | 8 Nedre kurv |
| 3 Typeskilt | 9 Øvre spylearm |
| 4 Saltbeholder | 10 Øvre kurv |
| 5 Skyllemiddelbeholder | |
| 6 Oppvaskmiddelbeholder | |

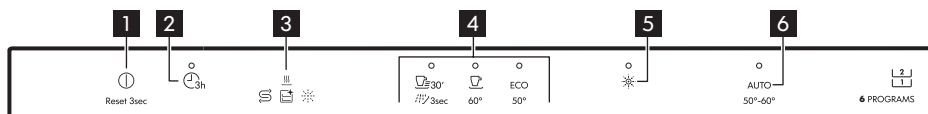

Betjeningspanel









- | | |
|--|----------------------------|
| 1 På/Av-knapp / Tilbakestillingsknapp | 5 Power Clean-knapp |
| 2 Starttidsforvalg-knapp | 6 AUTO programknapp |
| 3 Indikatorer | |
| 4 Program-knapper | |

Indikatorer

| Indikator | Beskrivelse |
|--|--|
|  | Skyllemiddelindikator. Den tennes når skyllemiddelbeholderen er tom. |
|  | Saltindikator. Den tennes når saltbeholderen er tom. |

| Indikator | Beskrivelse |
|---|---|
|  | Machine Care-indikator. Den tennes når apparatet trenger å rengjøres innvendig med programmet Machine Care. |
|  | Indikator for tørkefase. Den tennes når et program med tørkefasen er valgt. Den blinker under tørkefasen er i gang. |

Programoversikt

| Program | Oppvaskmaskinlast | Grad av smuss | Temperatur (°C) | Tid (min.) | Tilvalg | AutoOpen |
|--|---|------------------------------|-----------------|------------|---|----------|
|  Quick 30' | Servise, bestikk | Nytt smuss | 50 | 30 |  | ✓ |
|  Rinse & Hold | Alle typer vask | Alle grader av smuss | Kaldt vann | 15 | ✗ | ✗ |
|  90 Minutes | Servise, bestikk, gryter, panner | Normal, lett tørket på smuss | 60 | 90 |  | ✓ |
| ECO 1) | Servise, bestikk, gryter, panner | Normal, lett tørket på smuss | 50 | 227 |  | ✓ |
| AUTO | Servise, bestikk, gryter, panner | Alle | 50 - 60 | 120 - 170 | ✗ | ✓ |
| Machine Care | For rengjøring av insiden av produktet. Se «Rengjøring og vedlikehold». | | 70 | 60 | ✗ | ✓ |

1) Dette programmet gir deg mest mulig effektivt vann- og energiforbruk for normalt skittent bestikk og servise. Dette er standardprogrammet for testinstitutter. Dette programmet brukes til å vurdere samsvar med Ecodesign Commission forordning (EU) 2019/2022.

Alternativer

Du kan endre programvalget etter behov ved å aktivere alternativer.

Power Clean

 Power Clean forbedrer oppvaskresultatene av det valgte

programmet. Tilvalget øker vasketemperaturen og varigheten.

Grunnleggende innstillinger

| Tall | Innstillinger | Innstillingsverdi | Vannhardhet | |
|------|------------------------------------|-------------------|-------------|--------------------|
| | | | mmol/l | Tyske grader (°dH) |
| 1 | Vannmykner | 10 | 8.4 - 9.0 | 47 - 50 |
| | | 9 | 7.6 - 8.3 | 43 - 46 |
| | | 8 | 6.5 - 7.5 | 37 - 42 |
| | | 7 | 5.1 - 6.4 | 29 - 36 |
| | | 6 | 4.0 - 5.0 | 23 - 28 |
| | | 5 1) | 3.3 - 3.9 | 19 - 22 |
| | | 4 | 2.6 - 3.2 | 15 - 18 |
| | | 3 | 1.9 - 2.5 | 11 - 14 |
| | | 2 | 0.7 - 1.8 | 4 - 10 |
| | 1 2) | <0.7 | <4 | |
| 2 | Varsel om tom skyllemiddelbeholder | På/Av | | |
| 3 | Sluttlyd | På/Av | | |
| 4 | Automatisk døråpner | På/Av | | |
| 5 | Tastelyder | På/Av | | |



1) Fabrikkinnstilling.

2) Ikke bruk salt på dette nivået.

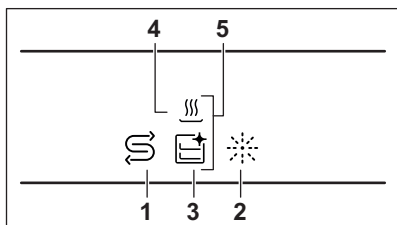
Når apparatet er i innstillingsmodus, representerer indikatorene på betjeningspanelet de tilgjengelige innstillingene. For hver innstilling blinker en dedikert indikator:









Innstillingsmodus



| Knapp | Beskrivelse |
|---|---|
|  1h | Forrige-knapp Trykk på for å veksle mellom de grunnleggende innstillingene og for å endre verdiene deres. |
|  | OK-knapp Trykk på for å angi den valgte innstillingen og for å bekrefte endringen av verdien dens. |

| Knapp | Beskrivelse |
|---|---|
|  | Neste-knapp Trykk på for å veksle mellom de grunnleggende innstillingene og for å endre verdiene deres. |

Slik endrer du en innstilling

- For å gå inn i innstillingsmodus, trykk og hold  30' og **ECO** samtidig i omtrent 3 sekunder.
 - Lampen relatert til  og indikatoren  blinker.
 - Indikatorene , , og  er på.
 - Lampen relatert til programknappene tennes.
- Trykk på **Forrige** eller **Neste** til indikatoren for den valgte innstillingen blinker.

Lampen relatert til  indikerer gjeldende innstillingsverdi:

- For innstillinger med 2 verdier (på og av), lyset er enten på (= innstillingen er på) eller av (= innstillingen er slått av).
 - For innstillinger med flere verdier (nivåer), blinker lampen. Antall blink viser gjeldende innstillingsverdien (f.eks. 5 blink + pause + 5 blink ... = nivå 5).
- Trykk på **OK** for å endre innstillingen.
 - Lampen relatert til innstillingen er tent.
 - De andre indikatorene er av.
 - Lampen relatert til  indikerer den gjeldende innstillingsverdien.
 - Trykk på **Forrige** eller **Neste** for å endre verdien.
 - Trykk på **OK** for å bekrefte innstillingsverdien.
 - Den nye innstillingsverdien lagres.
 - Apparatet går tilbake til listen for grunnleggende innstillinger.
 - Trykk og hold  30' og **ECO** nede i omtrent 3 sekunder for å lukke innstillingsmodus. Produktet bytter til programvalget.

AutoOpen

AutoOpen forbedrer tørkeresultatet med mindre strømforbruk. Døren åpner seg automatisk under tørkesyklusen og blir stående åpen.

- ⚠ FORSIKTIG!** Ikke prøv å lukke døren før etter 2 minutter etter en automatisk åpning. Dette kan skade produktet.

- ⚠ FORSIKTIG!** Hvis barn, kjæledyr eller personer med funksjonshemninger har tilgang til produktet, må du deaktivere AutoOpen. Den automatiske åpningen av døren kan utgjøre en fare og utsette mulige farer inne i produktet (som kniver, skarpe gjenstander, kjemikalier).

Før første gangs bruk

Sørg for at det aktuelle nivået på vannmykneren er justert i forhold til vannhardheten.

Bruk programmet Quick 30' til å fjerne rester fra produksjonsprosessen.

1. Hell 1 liter vann i saltbeholderen.
2. Hell 1 kg salt i saltbeholderen. Bruk salt som bare er beregnet for oppvaskmaskiner.
3. Fyll skyllemiddelbeholderen.
4. Åpne vannkranen.
5. Velg Quick 30'-programmet og lukk oppvaskmaskindøren for å starte det.

Bruk ikke oppvaskmiddel og sett ikke oppvask i kurvene.

- ⚠ FORSIKTIG!** Det kan komme vann og salt ut av saltbeholderen når du fyller den. For å forhindre korrosjon, må du starte et program umiddelbart etter at du har fylt saltbeholderen.

- i** Hvis du ikke bruker produktet, kan du lukke vannkranen.

Feilsøking

Hvis du støter på et problem med produktet, sjekk kapittelet "Feilsøking" i den

fullstendige versjonen av bruksanvisningen som er tilgjengelig på: www.ikea.com.

Tekniske data

| Produkttype | Helintegriert oppvaskmaskin | |
|------------------------------------|---|-----------------------|
| Mål | Bredde / høyde / dybde (mm) | 596 / 818 - 898 / 550 |
| Elektrisk tilkobling ¹⁾ | Spenning (V) | 220 - 240 |
| | Frekvens (Hz) | 50 |
| Vannforsynings-trykk | Min. / maks. bar (MPa) | 0.5 (0.05) / 10 (1.0) |
| Vannforsyning | Kaldt vann eller varmt vann ²⁾ | maks 60° C |

| Kapasitet | Kuverter | 13 |
|-----------|----------|----|
|-----------|----------|----|

- 1) Referer til klassifiseringsskiltet for andre verdier.
2) Hvis varmtvannet kommer fra alternativ energikilde (for eksempel solcellepaneler, vindenergi), bruk varmtvannsforsyningen for å redusere strømforbruket.

Kobling til EU EPREL-databasen

QR-koden på energietiketten som fulgte med produktet, gir en nettløse til registrering av dette produktet i EU EPREL-databasen. Oppbevar energietiketten

kun for henvisning med denne brukerhåndboken samt alle andre dokumenter som fulgte med dette produktet.

Det er også mulig å finne informasjonen relatert til ytelsen til produktet i EU EPREL-databasen med koblingen <https://eprel.ec.europa.eu> og modellnavnet, samt produktnummeret som du finner på merkeskiltet til produktet. Se etter i kapitlet «Produktbeskrivelse».

Gå til www.theenergylabel.eu for mer detaljert informasjon om energietiketten.

Tuotekuvaus

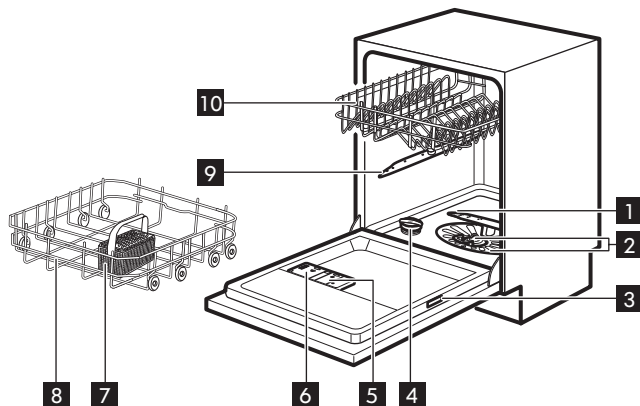



- | | |
|---|-----------------------------|
| 1 Alempi suihkuvarsi | 7 Ruokailuvälinekori |
| 2 Sihdit | 8 Alempi kori |
| 3 Arvokilpi | 9 Ylempi suihkuvarsi |
| 4 Suolalokero | 10 Ylempi kori |
| 5 Huuhtelukirkasteen annostelija | |
| 6 Pesuaineen annostelija | |

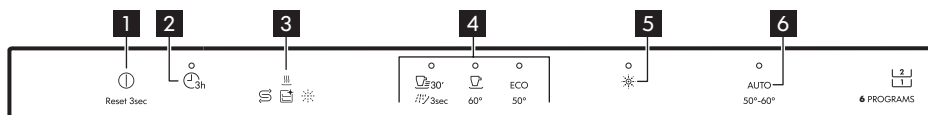

Käyttöpaneeli





- | | |
|--|--------------------------------------|
| 1 Virtapainike / nollauspainike | 5 Power Clean -painike |
| 2 Ajustimen painike | 6 AUTO Ohjelmanvalintapainike |
| 3 Merkkivalot | |
| 4 Ohjelmanvalintapainikkeet | |

Merkkivalot

| Merkkivalo | Kuvaus |
|--|---|
|  | Rypistymiseneston merkkivalo. Palaa, kun huuhtelukirkastelokeron täyttö on tarpeen. |
|  | Suolan merkkivalo. Palaa, kun suolalokeron täyttö on tarpeen. |

| Merkkivalo | Kuvaus |
|---|--|
|  | Machine Care -merkkivalo. Palaa, kun laitteen sisäosan puhdistus Machine Care -ohjelmalla on tarpeen. |
|  | Kuivausvaiheen merkkivalo. Palaa, kun valitset kuivausvaiheen sisältävän ohjelman. Viilkuu kuivausvaiheen ollessa käynnissä. |

Ohjelmien yleiskatsaus

| Ohjelma | Täytetty astianpesukoneellinen | Likaisuusaste | Lämpötila (°C) | Kellonaika (min) | Lisätoiminnot | AutoOpen |
|--|---|---|----------------|------------------|---|----------|
|  Quick 30' | Astiasto ja ruokailuvälineet | Äskettäin likaantuneet | 50 | 30 |  | ✓ |
|  Rinse & Hold | Kaikenlaiset astiat | Kaikki likaisuusasteet | Kylmä vesi | 15 | ✗ | ✗ |
|  90 Minutes | Astiasto, ruokailuvälineet, kattilat, pannut | Tavallinen määrä, hieman kiinni kuivunut lika | 60 | 90 |  | ✓ |
| ECO 1) | Astiasto, ruokailuvälineet, kattilat, pannut | Tavallinen määrä, hieman kiinni kuivunut lika | 50 | 227 |  | ✓ |
| AUTO | Astiasto, ruokailuvälineet, kattilat, pannut | Kaikki | 50 - 60 | 120 - 170 | ✗ | ✓ |
| Machine Care | Laitteen sisäosan puhdistus. Katso kohta "Puhdistus ja ylläpito". | | 70 | 60 | ✗ | ✓ |

1) Tämä ohjelma pesee likaiset astiat ja ruokailuvälineet tehokkaimmalla veden- ja energiankulutuksella. Tämä on testilaitosten standardiohjelma. Tätä ohjelmaa on käytetty arvioitaessa, noudattaako laite Ecodesign Commission (ekologisen suunnittelun komission) asetusta (EU) 2019/2022.

Lisätoiminnot

Voit säätää ohjelmavalinnan omien tarpeidesi mukaan kytkemällä lisätoimintoja toimintaan.

Power Clean

 Power Clean parantaa valitun ohjelman astianpesutulosta. Lisätoiminto nostaa pesulämpötilaa ja pidentää kestoa.

Perusasetukset

| Numero | Asetukset | Asetusarvo | Veden kovuus | |
|--------|--|--------------------|--------------|--------------------------|
| | | | mmol / l | Saksalaiset asteet (°dH) |
| 1 | Vedenpehmen- nin | 10 | 8.4 - 9.0 | 47 - 50 |
| | | 9 | 7.6 - 8.3 | 43 - 46 |
| | | 8 | 6.5 - 7.5 | 37 - 42 |
| | | 7 | 5.1 - 6.4 | 29 - 36 |
| | | 6 | 4.0 - 5.0 | 23 - 28 |
| | | 5 1) | 3.3 - 3.9 | 19 - 22 |
| | | 4 | 2.6 - 3.2 | 15 - 18 |
| | | 3 | 1.9 - 2.5 | 11 - 14 |
| | | 2 | 0.7 - 1.8 | 4 - 10 |
| | | 1 2) | <0.7 | <4 |
| 2 | Huuhtelukir- kaste loppu -il- moitus | Päälle/Pois päältä | | |
| 3 | Lopetusääni- merkki | Päälle/Pois päältä | | |
| 4 | Autom. luukun avaus | Päälle/Pois päältä | | |
| 5 | Painikenaänet | Päälle/Pois päältä | | |

1) Tehdasasetus:

2) Älä käytä suolaa tällä tasolla.

Kun laite on asetustilassa, käyttöpaneelin merkkivalot esittävät käytettävissä olevat asetukset. Kunkin asetuksen kohdalla vilkkuu erillinen merkkivalo:

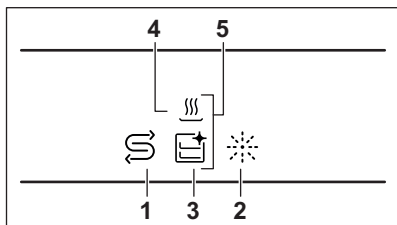

Asetustila

| -painike | Kuvaus |
|----------|---|
| | Edellinen -painike. Voit selata perusasetuksia ja säätää niiden arvoja painamalla. |
| | OK -painike. Voit siirtyä valittuun asetukseen ja vahvistaa sen arvon muutoksen painamalla. |
| | Seuraava -painike. Voit selata perusasetuksia ja säätää niiden arvoja painamalla. |

Asetuksen muuttaminen

1. Paina ja pidä painettuina samanaikaisesti painikkeita ja noin kolmen sekunnin ajan päästäksesi asetustilaan.

- Merkkivalo ja vilkkuvat.
- Merkkivalot , ja syttyvät.
- Ohjelmanvalintapainikkeiden merkkivalot palavat.

2. Paina painiketta **Edellinen** tai **Seuraava**, kunnes valitsemaasi asetukseen liittyvä merkkivalo vilkkuu.

-merkkivalo osoittaa nykyisen asetuservon:

- Kaksiarvoisissa (päällä ja pois päältä) asetuksissa merkkivalo joko palaa (= asetus on päällä) tai on sammunut (= asetus on pois päältä).
- Moniarvoisissa (tasot) asetuksissa merkkivalo vilkkuu. Vilkkumiskertojen määrä osoittaa nykyisen asetuservon (esim. 5 vilkkumiskertaa + tauko + 5 vilkkumiskertaa... = taso 5).

3. Syötä asetus painamalla **OK**.

- Asetuksen merkkivalo palaa.
- Muut merkkivalot ovat pois päältä.
- -merkkivalo osoittaa nykyisen asetuservon.

4. Vaihda arvoa **Edellinen**- tai **Seuraava**-painikkeella.

5. Vahvista asetuservo painamalla **OK**.

- Uusi asetuservo tallentuu muistiin.
- Laite palaa perusasetuksiin luetteloon.

6. Paina ja pidä painettuina samanaikaisesti painikkeita ja noin kolmen sekunnin ajan poistuaksesi asetustilasta.

Laite vaihtaa ohjelmavaliintaansa.

AutoOpen

AutoOpen parantaa kuivaustulosta pienemmällä energiankulutuksella. Laitteen luukku avautuu automaattisesti kuivausvaiheen aikana ja jää raolleen.

⚠ HUOMIO! Älä yritä sulkea laitteen luukkuja 2 minuutin kuluessa sen automaattisesta avautumisesta. Jos teet niin, laite voi vaurioitua.

⚠ HUOMIO! Jos lapset, lemmikit tai vammaiset voivat päästä käsiksi laitteeseen, deaktivoi eli poista AutoOpen käytöstä. Luukun automaattinen avautuminen voi aiheuttaa vaaran ja paljastaa mahdolliset vaarat laitteen sisällä (kuten veitset, terävät esineet, kemikaalit).

Ennen ensikäyttöä

Varmista, että vedenpehmentimen nykyinen taso on säädetty vastaamaan käyttöveden kovuutta.

Käynnistä Quick 30'-ohjelma valmistusprosessin jäämien poistamiseksi.

1. Kaada 1 litra vettä suola-astiaan.
2. Laita 1 kg suolaa suola-astiaan. Käytä ainoastaan astianpesukoneisiin tarkoitettua karkeaa suolaa.
3. Täytä huuhtelukirkasteastia.
4. Avaa vesihana.
5. Valitse ohjelma Quick 30' ja sulje astianpesukoneen luukku

käynnistääksesi sen. Älä käytä pesuainetta tai aseta astioita koreihin.

⚠ HUOMIO! Vettä ja suolaa voi tulla ulos suolasäiliöstä, kun täytät sen. Käynnistä ohjelma välittömästi suolasäiliön täyttämisen jälkeen korroosion estämiseksi.

i Jos et käytä laitetta, sulje vesihana.

Vianmääritys

Jos laitteessasi on ongelmia, tarkista luku "Vianmääritys" käyttöoppaan täydestä

versiosta, joka on saatavilla osoitteessa: www.ikea.com.

Tekniset tiedot

| Tuotetyppi | Täysin integroitu astianpesukone | |
|------------------|----------------------------------|-----------------------|
| Mitat | Leveys / korkeus / syvyys (mm) | 596 / 818 - 898 / 550 |
| Sähkökytkentä 1) | Jännite (V) | 220 - 240 |
| | Taajuus (Hz) | 50 |
| Vedenpaine | Vähimm. / enimm. baaria (MPa) | 0,5 (0,05) / 10 (1,0) |
| Vedensyöttö | Kylmä vesi tai kuuma vesi 2) | enint. 60 °C |

| Tilavuus | Astiaastojen lukumäärä | 13 |
|----------|------------------------|----|
|----------|------------------------|----|

1) Katso muut arvot arvokilvestä.
2) Jos vesi kuunnetaan vaihtoehtoisen, ympäristöystävällisemmän energian avulla (esim. aurinkopaneleilla tai eolisella energialla), käytä kuumaa vettä energiankulutuksen vähentämiseksi.

Linkki EU EPREL -tietokantaan

Laitteen mukana toimitetun energialuokkamerkinnän QR-koodi sisältää linkin verkkosivustolle, jossa tämä laite voidaan rekisteröidä EU EPREL -tietokantaan.

Säilytä energialuokamerkintää yhdessä käyttöohjeen ja kaikkien muiden tämän laitteen mukana toimitettujen asiakirjojen kanssa.

Tuotteen suorituskykytietoja on mahdollista tarkastella EU EPREL -tietokannassa käyttämällä linkkiä <https://eprel.ec.europa.eu> sekä laitteen arvokilvessä olevaa mallin nimeä ja tuotenumeroa. Katso luku "Tuotteen kuvaus".

Lisätietoa energialuokasta on saatavilla osoitteesta www.theenergylabel.eu.

Produktbeskrivning

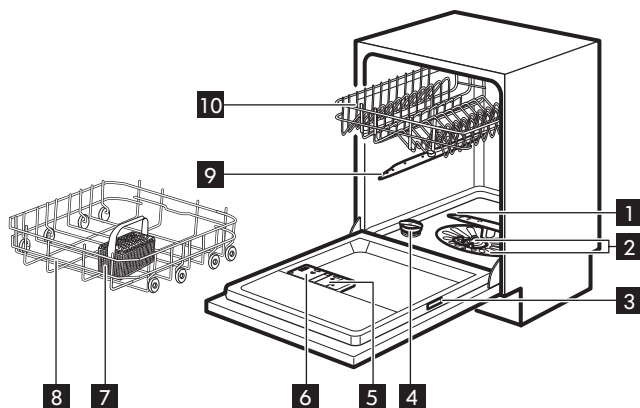



- | | |
|-----------------------------|-----------------------|
| 1 Nedre spolarm | 7 Bestickkorg |
| 2 Filter | 8 Nedre korg |
| 3 Typskylt | 9 Övre spolarm |
| 4 Saltbehållare | 10 Övre korg |
| 5 Spolglansbehållare | |
| 6 Diskmedelsfack | |

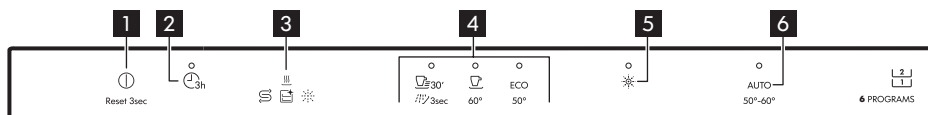

Kontrollpanel









- | | |
|---|----------------------------|
| 1 On/Off-knapp/återställningsknapp | 5 Power Clean-knapp |
| 2 Knapp för fördröjd start | 6 AUTO programknapp |
| 3 Indikatorlampor | |
| 4 Programvalsknappar | |

Indikatorer

| Indikator | Beskrivning |
|--|---|
|  | Indikator för spolglans. Den lyser när spolglans behöver fyllas på. |
|  | Saltindikator. Den lyser när saltbehållaren behöver fyllas på. |

| Indikator | Beskrivning |
|---|---|
|  | Machine Care indikator Den lyser när maskinen behöver rengöras inuti med Machine Care-programmet. |
|  | Indikator för torkfas. Den lyser när ett program med en torkfas har valts. Den blinkar när torkfasen pågår. |

Programöversikt

| Program | Diskmaskinsladdning | Smutsgrad | Temperatur (°C) | Tid (min) | funktioner | AutoOpen |
|--|---|------------------------------|-----------------|-----------|---|----------|
|  Quick 30' | Porslin, bestick | Nyligen nedsmutsad disk | 50 | 30 |  | ✓ |
|  Rinse & Hold | Alla typer av disk | Alla smutsgrader | Kallt vatten | 15 | ✗ | ✗ |
|  90 Minutes | Porslin, bestick, kastruller, pannor | Normalt lätt in-torkad smuts | 60 | 90 |  | ✓ |
| ECO ¹⁾ | Porslin, bestick, kastruller, pannor | Normalt lätt in-torkad smuts | 50 | 227 |  | ✓ |
| AUTO | Porslin, bestick, kastruller, pannor | Alla | 50 - 60 | 120 - 170 | ✗ | ✓ |
| Machine Care | Rengöring av apparatens insida. Se "Rengöring och underhåll". | | 70 | 60 | ✗ | ✓ |

1) Med det här programmet får du den mest effektiva vattenanvändningen och energiförbrukningen för normalt nedsmutsat porslin och bestick. Detta är standardprogrammet för testinstitut. Det här programmet används för att bedöma överensstämmelse med förordningen om ekodesign (EU) 2019/2022.

Alternativ

Du kan ändra programval efter dina behov genom att aktivera funktioner.

Power Clean

 Power Clean förbättrar diskresultatet för valt program. Alternativet ökar temperaturen och programlängden.

Normalinställningar

| Num-mer | Inställningar | Inställningsvärde | Vattenhärdhet | |
|---------|-----------------------------------|-------------------|---------------|--------------------|
| | | | mmol/l | Tyska värden (°dH) |
| 1 | Vattenavhärda-re | 10 | 8.4 - 9.0 | 47 - 50 |
| | | 9 | 7.6 - 8.3 | 43 - 46 |
| | | 8 | 6.5 - 7.5 | 37 - 42 |
| | | 7 | 5.1 - 6.4 | 29 - 36 |
| | | 6 | 4.0 - 5.0 | 23 - 28 |
| | | 5 1) | 3.3 - 3.9 | 19 - 22 |
| | | 4 | 2.6 - 3.2 | 15 - 18 |
| | | 3 | 1.9 - 2.5 | 11 - 14 |
| | | 2 | 0.7 - 1.8 | 4 - 10 |
| | 1 2) | <0.7 | <4 | |
| 2 | Meddelande om tomt spolg-lansfack | På/Av | | |
| 3 | Slutjud | På/Av | | |
| 4 | Aut. lucköppn. | På/Av | | |
| 5 | Knappljud | På/Av | | |

1) Fabriksinställning.

2) Använd inte salt på denna nivå.

När maskinen är i inställningsläge representerar indikatorerna på kontrollpanelen möjliga inställningar. För varje inställning blinkar en dedikerad indikator:

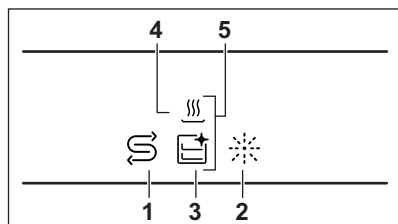

Inställningsläge

| Knapp | Beskrivning |
|-------|--|
| 1h | Föregående-knapp. Tryck för att växla mellan normalinställningar och ändra deras värden. |
| | OK-knapp. Tryck för att öppna vald inställning och bekräfta ändring av värdet. |
| | Nästa-knapp. Tryck för att växla mellan normalinställningar och ändra deras värden. |

Ändra en inställning

- Tryck och håll in 30' och **ECO** samtidigt i ca 3 sekunder för att öppna inställningsläget.
 - Lampan för och indikatorn blinkar.
 - Indikatorerna , och är tända.
 - Lamporna för programknapparna lyser.
- Tryck på **Föregående** eller **Nästa** tills kontrolllampan för den valda inställningen blinkar.

Lampan för indikerar aktuellt inställt värde:

- För inställningarna med två värden (på och av) är lampan antingen på (= inställningen på) eller av (= inställningen är av).
 - För inställningarna med flera värden (nivåer) blinkar lampan. Antalet blinkningar visar aktuell inställning (t.ex. 5 blinkningar + paus + 5 blinkningar... = nivå 5).
- Tryck på **OK** för att aktivera inställningen.
 - Lampan för inställningen lyser.
 - De andra indikatorerna är släckta.
 - Lampan för indikerar aktuellt inställt värde.
 - Tryck på **Föregående** eller **Nästa** för att ändra värdet.
 - Tryck på **OK** för att bekräfta inställningsvärdet.
 - Det nya inställningsvärdet sparas.
 - Produkten återgår till normalinställningslistan.
 - Tryck och håll in 30' och **ECO** samtidigt i ca 3 sekunder för att lämna inställningsläget.

Produkten växlar till programval.

AutoOpen

AutoOpen förbättrar torkningsresultatet med lägre energiförbrukning. Under

torkningsfasen öppnas luckan automatiskt och lämnas på glänt.

- ⚠ FÖRSIKTIGHET!** Försök att inte stänga luckan inom 2 minuter efter att den har öppnats automatiskt. Det kan skada maskinen.

- ⚠ FÖRSIKTIGHET!** Inaktivera AutoOpen om barn, husdjur eller personer med funktionsnedsättning har tillgång till produkten. Den automatiska öppningen av luckan kan utgöra en fara och exponera potentiella faror inuti produkten (t.ex. knivar, vassa föremål, kemikalier).

Före första användning

Kontrollera att vattenavhjärdarens aktuella nivå överensstämmer med vattentillförselns hårdhet.

Använd programmet Quick 30' att ta bort rester från tillverkningsprocessen.

1. Häll 1 liter vatten i saltbehållaren.
2. Häll 1 kg salt i saltbehållaren. Använd endast grovt salt avsett för diskmaskinen.
3. Fyll på spolglansfacket.
4. Öppna vattenkranen.
5. Välj program Quick 30' och stäng diskmaskinens lucka för att starta det.

Använd inte diskmedel och ladda inte korgarna med disk.

- ⚠ FÖRSIKTIGHET!** Vatten och avhärtnings salt kan rinna ut från saltbehållaren när du fyller på den. När du har fyllt på saltbehållaren ska du starta ett program genast för att förhindra rost.

- i** Stäng vattenkranen om du inte använder apparaten.

Felsökning

Om du stöter på ett problem med din produkt, se kapitlet "Felsökning" i den fullständiga versionen av

användarhandboken som finns på: www.ikea.com.

Teknisk information

| Produkttyp | Helintegrerad diskmaskin | |
|----------------------------|---|-----------------------|
| Mått | Bredd / Höjd / Djup (mm) | 596 / 818 - 898 / 550 |
| Elanslutning ¹⁾ | Spänning (V) | 220 - 240 |
| | Frekvens (Hz) | 50 |
| Vattentryck | Min./max. bar (MPa) | 0.5 (0.05) / 10 (1.0) |
| Vattenförsörjning | Kallt vatten eller varmt vatten ²⁾ | max 60 °C |

| Kapacitet | Kuvert | 13 |
|-----------|--------|----|
|-----------|--------|----|

- 1) Se märkskylten för andra värden.
2) Om varmvattnet kommer från en alternativ energikälla (t.ex. solpaneler eller vindkraft) kan en varmvattensanslutning användas för att minska energiförbrukningen.

Länk till EU EPREL databas

QR-koden på energimärkningsetiketten som levereras med produkten ger en webblänk till registreringen av denna produkt i EU

EPREL-databasen. Förvara energimärkningsetiketten som referens tillsammans med användarhandboken och alla andra dokument som medföljer denna produkt.

Det går att hitta information relaterad till produktens prestanda i EU EPREL-databasen med hjälp av länken <https://eprel.ec.europa.eu> och modellnamnet och produktnumret som du kan hitta på maskinens typskylt. Se kapitlet "Produktbeskrivning".

För mer detaljerad information om energimärkning, gå in på www.theenergylabel.eu.



156809551-A-282022

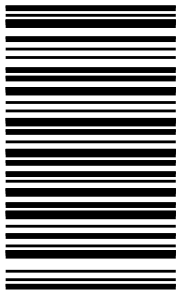

© Inter IKEA Systems B.V. 2022

21552

AA-2316353-2