

# MEDELSTOR

GB

DE

FR

IT

PT

ES

NL

DK

NO

FI

SE



Design and Quality  
IKEA of Sweden

<b>ENGLISH</b>	<b>5</b>
<b>DEUTSCH</b>	<b>10</b>
<b>FRANÇAIS</b>	<b>15</b>
<b>ITALIANO</b>	<b>20</b>
<b>PORTUGUÊS</b>	<b>25</b>
<b>ESPAÑOL</b>	<b>30</b>
<b>NEDERLANDS</b>	<b>35</b>
<b>DANSK</b>	<b>40</b>
<b>NORSK</b>	<b>45</b>
<b>SUOMI</b>	<b>50</b>
<b>SVENSKA</b>	<b>55</b>

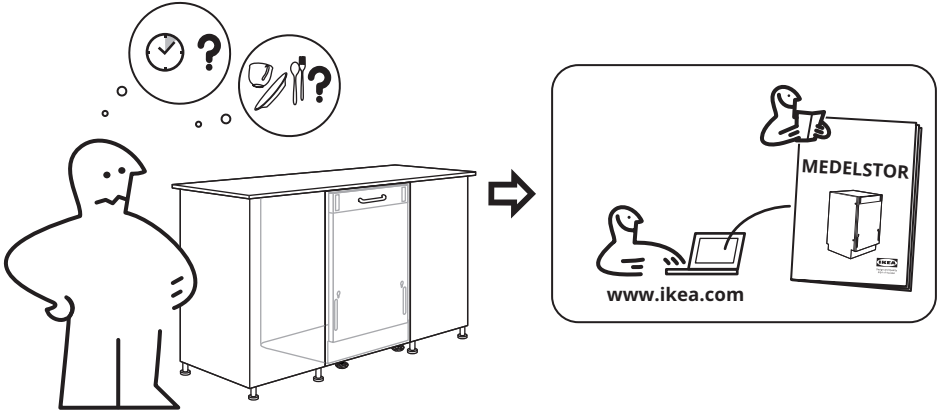

1

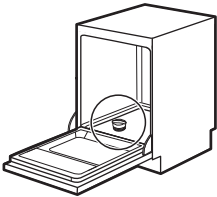

2



3



4



5

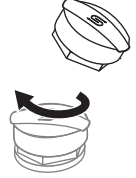

1

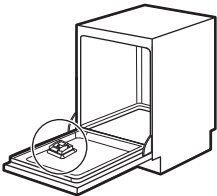

2

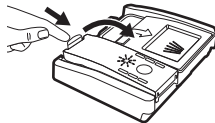

3

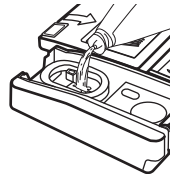

4



I

1



2



3

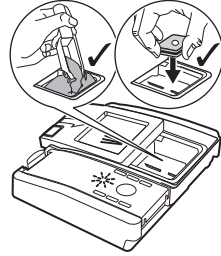

4

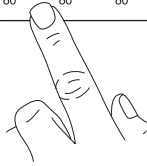
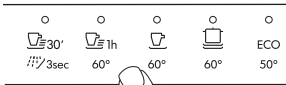

5

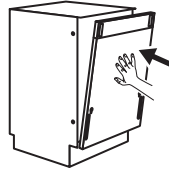

h

1

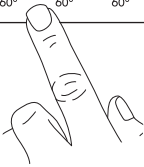

2

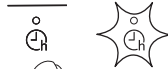

3

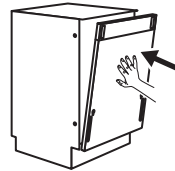

1-24 h

## Product description

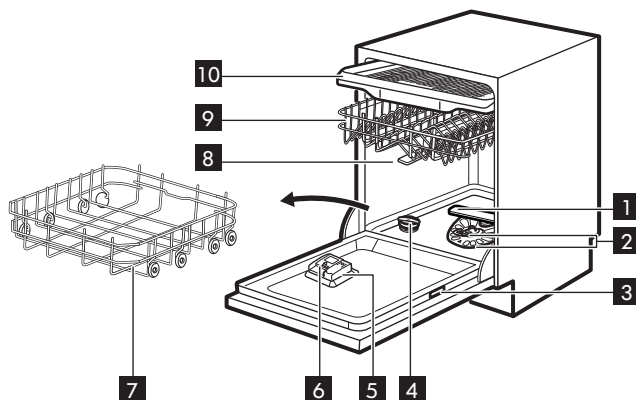

**1** Lower spray arm

**2** Filters

**3** Rating plate

**4** Salt container

**5** Rinse aid dispenser

**6** Detergent dispenser

**7** Lower basket

**8** Upper spray arms

**9** Upper basket

**10** Cutlery drawer

### Beam-on-Floor

Beam-on-Floor is a light displayed on the floor below the appliance door.

- When a programme starts, a white light is on and stays on for the duration of the programme.

- When the programme is completed, the white light is off.
- When the appliance has a malfunction, the white light flashes.

**i** Beam-on-Floor is off when the appliance is deactivated.

Control panel

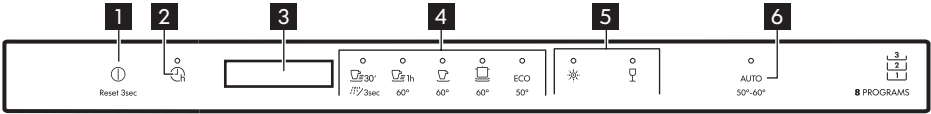

- 1 On/Off button / Reset button
- 2 Delay start button
- 3 Display
- 4 Programme buttons

- 5 Option buttons
- 6 AUTO programme button

Display

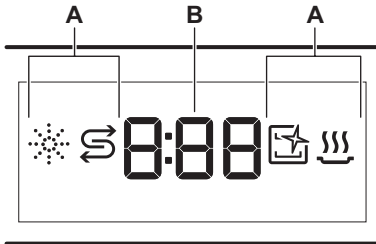



- A. Indicators
- B. Time indicator

Indicators

Indicator	Description
	Rinse aid indicator. It is on when the rinse aid dispenser needs refilling.
	Salt indicator. It is on when the salt container needs refilling.
	Machine Care indicator. It is on when the appliance needs internal cleaning with the Machine Care programme.
	Drying phase indicator. It is on when a programme with the drying phase is selected. It flashes when the drying phase operates.

Programmes overview

Programme	Dishwasher load	Degree of soil	Temperature (°C)	Time (min)	Options	AutoOpen
 Quick 30'	Crockery, cutlery	Fresh soil	50	30	 	✓
 Rinse & Hold	All types of load	All degrees of soil	Cold water	15	X	X
 60 Minutes	Crockery, cutlery	Fresh, lightly dried-on soil	60	60	 	✓
 90 Minutes	Crockery, cutlery, pots, pans	Normal, lightly dried on soil	60	90	 	✓

Programme	Dishwasher load	Degree of soil	Temperature (°C)	Time (min)	Options	AutoOpen
 Intensive	Crockery, cutlery, pots, pans	Normal to heavy, dried-on soil	60	160		✓
ECO 1)	Crockery, cutlery, pots, pans	Normal, lightly dried on soil	50	240		✓
AUTO	Crockery, cutlery, pots, pans	All	50 - 60	120 - 170	X	✓
Machine Care	For cleaning the appliance interior. Refer to "Cleaning and Maintenance".		70	60	X	✓

1) This programme offers the most efficient use of water and energy consumption for crockery and cutlery with normal soil. This is the standard programme for test institutes. This programme is used to assess compliance with the Ecodesign Commission Regulation (EU) 2019/2022.

**Options**

You can adjust the programme selection to your needs by activating options.

**Power Clean**

 Power Clean improves the dishwashing results of the selected programme. The option increases the wash temperature and duration.

**Gentle / Glass**

 Gentle / Glass prevents delicate load, glassware in particular, from damaging. The option prevents rapid changes in the dishwashing temperature of the selected programme and reduces it to 45 °C.



**Basic settings**

Number	Setting	Setting value	Water hardness	
			mmol/l	German degrees (°dH)
1	Water softener	10	8.4 - 9.0	47 - 50
		9	7.6 - 8.3	43 - 46
		8	6.5 - 7.5	37 - 42
		7	5.1 - 6.4	29 - 36
		6	4.0 - 5.0	23 - 28
		5 1)	3.3 - 3.9	19 - 22
		4	2.6 - 3.2	15 - 18
		3	1.9 - 2.5	11 - 14
		2	0.7 - 1.8	4 - 10
		1 2)	<0.7	<4
2	Rinse aid level	0A - 8A		
3	End sound	1b (on) / 0b (off)		
4	Auto door open	1o (on) / 0o (off)		
5	Key tones	1F (on) / 0F (off)		





6	Latest programme selection	1H (on) / 0H (off)
---	----------------------------	--------------------

1) Factory setting.  
2) Do not use salt at this level.

**Setting mode**

Button	Description
 1h	Previous button. Press to switch between the basic settings and to change their values.
	OK button. Press to enter the selected setting and to confirm changing its value.
	Next button. Press to switch between the basic settings and to change their values.

## How to change a setting

1. Press and hold simultaneously  30' and **ECO** for about 3 seconds to enter setting mode.
  - The lights: ,  and  are on.
  - The display shows the current value of the first available setting.
2. Press **Previous** or **Next** to select the setting.  
The display shows the current setting value (a digit and the dedicated letter).
3. Press **OK** to enter the setting.  
The current setting value flashes.
4. Press **Previous** or **Next** to change the value.
5. Press **OK** to confirm the setting value.
  - The new setting value is saved.
  - The appliance returns to the basic settings list.
6. Press and hold simultaneously  30' and **ECO** for about 3 seconds to exit the setting mode.

The appliance switches to the programme selection.

## AutoOpen

AutoOpen improves the drying results with less energy consumption. The appliance door opens automatically during the drying phase and remains ajar.



**Caution!** Do not try to close the appliance door within 2 minutes after automatic opening. This can cause damage to the appliance.



**Caution!** If children, pets or people with disabilities have access to the appliance, deactivate AutoOpen. The automatic opening of the door may pose a danger and expose possible hazards inside the appliance (such as knives, sharp objects, chemicals).

## Before first use

Make sure that the current level of the water softener is adjusted to the hardness of the water supply.

Use the programme Quick 30' to remove residues from the manufacturing process.

1. Pour 1 litre of water in the salt container.
2. Put 1 kg of salt in the salt container.  
Use rough salt designed for dishwashers only.
3. Fill the rinse aid dispenser.
4. Open the water tap.
5. Select the programme Quick 30' and close the dishwasher door to start it. Do

not use detergent and do not put dishes in the baskets.



**Caution!** Water and salt may come out of the salt container when you fill it. After you fill the salt container, immediately start a programme to prevent corrosion.



If you do not use the appliance, close the water tap.

## Troubleshooting

If you encounter an issue with your appliance, check "Troubleshooting" chapter

in the full version of the User Manual available on: [www.ikea.com](http://www.ikea.com).



## Technical information

Product type	Fully integrated dishwasher	
Dimensions	Width / height / depth (mm)	446 / 818 - 898 / 550
Electrical connection <sup>1)</sup>	Voltage (V)	220 - 240
	Frequency (Hz)	50
Water supply pressure	Min. / max. bar (MPa)	0.5 (0.05) / 10 (1.0)
Water supply	Cold water or hot water <sup>2)</sup>	max 60 °C
Capacity	Place settings	10

*1) Refer to the rating plate for other values.*

*2) If the hot water comes from alternative source of energy, (e.g. solar panels, aeolian energy), use the hot water supply to decrease energy consumption.*

### Link to the EU EPREL database

The QR code on the energy label supplied with the appliance provides a web link to the registration of this appliance in the EU EPREL database. Keep the energy label for reference together with the user manual and all other documents provided with this appliance.

It is possible to find information related to the performance of the product in the EU EPREL database using the link <https://eprel.ec.europa.eu> and the model name and product number that you can find on the rating plate of the appliance. Refer to the chapter "Product description".

For more detailed information about the energy label, visit [www.theenergylabel.eu](http://www.theenergylabel.eu).

## Produktbeschreibung

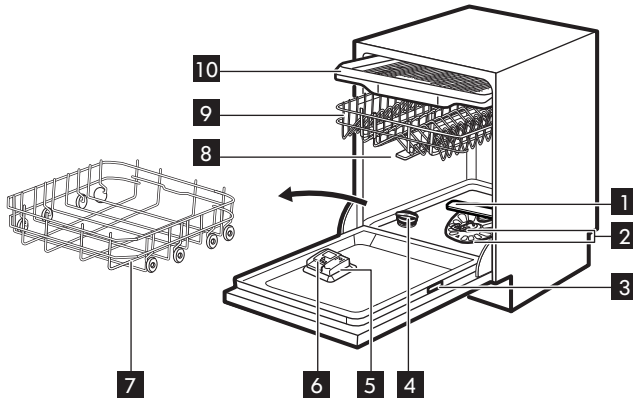

**1** Unterer Sprüharm

**2** Siebe

**3** Typenschild

**4** Salzbehälter

**5** Klarspülmittel-Dosierer

**6** Reinigungsmittel-Spender

**7** Unterer Korb

**8** Obere Sprüharme

**9** Oberer Korb

**10** Besteckschublade

### Beam-on-Floor

Beam-on-Floor ist ein Lichtstrahl, der unterhalb der Gerätetür auf den Boden projiziert wird.

- Nach dem Start eines Programms leuchtet der weiße Lichtstrahl und bleibt während der gesamten Programmdauer eingeschaltet.

- Nach Programmende erlischt der weiße Lichtstrahl.
- Bei einer Störung des Geräts blinkt der weiße Lichtstrahl.

**i** Nach dem Abschalten des Gerätes erlischt der Beam-on-Floor.

**Bedienfeld**



- 1** Ein-/Aus-Taste / Reset-Taste
- 2** Taste Zeitvorwahl
- 3** Display
- 4** Programmtasten

- 5** Optionstasten
- 6** Programmtaste AUTO

**Display**

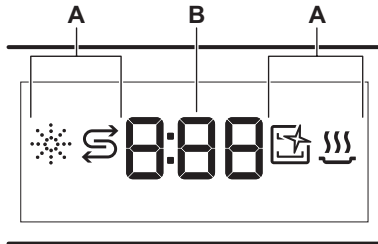

**B. Zeitanzeige**









**Anzeigen**

Anzeige	Beschreibung
	Klarspülmittelanzeige. Leuchtet, wenn der Klarspülmittel-Dosierer nachgefüllt werden muss.
	Salzanzeige. Leuchtet, wenn der Salzbehälter nachgefüllt werden muss.
	Machine Care-Anzeige. Leuchtet, wenn der Geräteinnenraum mit dem Programm Machine Care gereinigt werden muss.
	Trocknungsphasenanzeige. Leuchtet, wenn ein Programm mit Trocknungsphase gewählt wurde. Blinkt während der Trocknungsphase.

**A. Kontrolllampen**

**Programmübersicht**

Programm	Beladung der Spülmaschine	Verschmutzungsgrad	Temperatur (°C)	Zeit (Min.)	Optionen	AutoOpen
 <b>Quick 30'</b>	Geschirr, Besteck	Frische Verschmutzung	50	30	 	✓
 <b>Rinse &amp; Hold</b>	Alle Arten von Beladung	Alle Arten von Verschmutzung	Kaltes Wasser	15	✗	✗
 <b>60 Minutes</b>	Geschirr, Besteck	Frische, leicht angetrocknete Verschmutzung	60	60	 	✓

Programm	Beladung der Spülmaschine	Verschmutzungsgrad	Temperatur (°C)	Zeit (Min.)	Optionen	AutoOpen
 <b>90 Minutes</b>	Geschirr, Besteck, Töpfe, Pfannen	Normale, leicht angetrocknete Verschmutzung	60	90	 	✓
 <b>Intensive</b>	Geschirr, Besteck, Töpfe, Pfannen	Normale bis stark angetrocknete Verschmutzung	60	160	 	✓
<b>ECO 1)</b>	Geschirr, Besteck, Töpfe, Pfannen	Normale, leicht angetrocknete Verschmutzung	50	240	 	✓
<b>AUTO</b>	Geschirr, Besteck, Töpfe, Pfannen	Alle	50 - 60	120 - 170	<b>X</b>	✓
<b>Machine Care</b>	Zum Reinigen des Innenraums des Geräts. Siehe „Reinigung und Wartung“.		70	60	<b>X</b>	✓

1) Dieses Programm gewährleistet den wirtschaftlichsten Wasser- und Energieverbrauch für normal verschmutztes Geschirr und Besteck. Dies ist das Standardprogramm für Prüfinstitute. Dieses Programm dient der Überprüfung der Einhaltung der Verordnung der Ecodesign-Kommission (EU) 2019/2022.

**Optionen**

Sie können die Programmwahl durch das Einschalten von Optionen an Ihre Bedürfnisse anpassen.

**Power Clean**

 Power Clean verbessert die Spülergebnisse des ausgewählten Programms. Die Option erhöht die Spültemperatur und die Programmdauer.

**Gentle / Glass**

 Gentle / Glass verhindert, dass empfindliches Ladegut, insbesondere Glaswaren, beschädigt wird. Die Option verhindert schnelle Änderungen der Waschtemperatur des ausgewählten Programms und reduziert sie auf 45 °C.

**Grundeinstellungen**

Nummer	Einstellung	Einstellen des Wertes	Wasserhärte	
			mmol/l	Deutsche Wasserhärtegrade (°dH)

<b>1</b>	WASSERENHÄRTER	10	8.4 - 9.0	47 - 50
		9	7.6 - 8.3	43 - 46
		8	6.5 - 7.5	37 - 42
		7	5.1 - 6.4	29 - 36
		6	4.0 - 5.0	23 - 28
		5 1)	3.3 - 3.9	19 - 22
		4	2.6 - 3.2	15 - 18
		3	1.9 - 2.5	11 - 14
		2 2)	0.7 - 1.8	4 - 10
	1 2)	<0.7	<4	
<b>2</b>	Klarspülerstufe	0A - 8A		
<b>3</b>	Endsignal	1b (Ein) / 0b (Aus)		

4	Autom. Tür öffnen	1o (Ein) / 0o (Aus)
5	Tastentöne	1F (Ein) / 0F (Aus)
6	Auswahl des zuletzt verwendeten Programms	1H (Ein) / 0H (Aus)

- 1) Werkseinstellung.  
 2) Verwenden Sie bei diesem Grad kein Salz.

**Einstellmodus**

Taste	Beschreibung
1h	Zurück-Taste Drücken Sie diese Taste, um zwischen den Grundeinstellungen umzuschalten und ihre Werte zu ändern.
	OK-Taste Drücken Sie diese Taste, um die gewünschte Einstellung aufzurufen, und bestätigen Sie die Änderung des Wertes.
	Weiter-Taste Drücken Sie diese Taste, um zwischen den Grundeinstellungen umzuschalten und ihre Werte zu ändern.

**Ändern einer Einstellung**

- Halten Sie zum Aufrufen des Einstellmodus 30' und **ECO** gleichzeitig etwa 3 Sekunden gedrückt.
  - Die Lichter: 1h, und sind eingeschaltet.
  - Das Display zeigt die aktuelle Einstellung für die erste verfügbare Einstellung an.
- Die entsprechenden Optionen werden mit **Zurück** oder **Weiter** eingestellt. Das Display zeigt den aktuell eingestellten Wert ein (eine Ziffer und den spezifischen Buchstaben).
- Drücken Sie die Taste **OK**, um die Einstellung zu öffnen.

Die aktuelle Einstellung blinkt.

- Drücken Sie **Zurück** oder **Weiter**, um den Wert zu ändern.
- Drücken Sie **OK** zur Bestätigung der Einstellung .
  - Der neue Einstellungswert wird gespeichert.
  - Das Gerät kehrt zur Liste der Grundeinstellungen zurück.
- Halten Sie 30' und **ECO** etwa 3 Sekunden gleichzeitig gedrückt, um den Einstellmodus zu beenden.

Das Gerät schaltet auf die Programmauswahl.

**AutoOpen**

AutoOpen verbessert die Trocknungsergebnisse bei geringerem Energieverbrauch. Die Gerätetür öffnet sich automatisch während der Trocknungsphase und bleibt einen Spaltbreit geöffnet.

**Vorsicht!** Versuchen Sie nicht, die Gerätetür innerhalb der ersten 2 Minuten nach der automatischen Öffnung zu schließen. Dies kann zu Schäden am Gerät führen.

**Vorsicht!** Wenn Kinder, Haustiere oder Menschen mit Behinderungen Zugang zum Gerät haben, deaktivieren Sie AutoOpen. Das automatische Öffnen der Tür kann Gefahren im Inneren des Geräts freilegen (z. B. Messer, scharfe Gegenstände, Chemikalien).

**Vor der ersten Verwendung**

Stellen Sie sicher, dass das aktuelle Niveau des Wasserenthärters auf die Härte der Wasserversorgung eingestellt ist.

Verwenden Sie das Quick 30' Programm, um Rückstände aus dem Herstellungsprozess zu entfernen.

- Gießen Sie 1 Liter Wasser in den Salzbehälter.
- Geben Sie 1 kg Salz in den Salzbehälter. Verwenden Sie ausschließlich speziell für Geschirrspüler bestimmtes grobkörniges Salz.
- Füllen des Klarspülerdosierers.
- Öffnen Sie den Wasserhahn.

5. Wählen Sie das Programm Quick 30' und schließen Sie die Tür des Geschirrspülers, um es zu starten. Verwenden Sie kein Reinigungsmittel und beladen Sie die Körbe nicht.

**⚠ Vorsicht!** Beim Befüllen des Salzbehälters können Wasser und Salz austreten. Starten Sie nach dem Füllen des Salzbehälters umgehend ein Programm, um Korrosion zu verhindern.

**i** Wenn Sie das Gerät nicht verwenden, schließen Sie den Wasserhahn.

## Problembekämpfung

Wenn Sie ein Problem mit Ihrem Gerät haben, lesen Sie das Kapitel „Fehlerbehebung“ in der Vollversion des

Benutzerhandbuchs, das auf folgenden Seiten verfügbar ist: [www.ikea.com](http://www.ikea.com).

## Technische Daten

Gerätetyp	Vollständig integrierte Spülmaschine	
Abmessungen	Breite/Höhe/Tiefe (mm)	446 / 818 - 898 / 550
	Elektrischer Anschluss <sup>1)</sup>	Spannung (V) Frequenz (Hz)
Druck der Wasserversorgung	Min./max. bar (MPa)	220 - 240 50
	Wasserzufuhr	0,5 (0,05) / 10 (1,0)
Fassungsvermögen	Kaltes Wasser oder heißes Wasser <sup>2)</sup>	max. 60 °C
	Einstellungen vornehmen	10

1) Weitere Werte finden Sie auf dem Typenschild.  
2) Wenn das heiße Wasser von einer alternativen Energiequelle (z. B. Solaranlage, Äolenkraft) kommt, dann verwenden Sie die Warmwasserversorgung, um den Energieverbrauch zu reduzieren.

Informationen bezüglich der Geräteleistung finden Sie in der EU EPREL-Datenbank mit Hilfe des Links <https://eprel.ec.europa.eu> sowie mit dem Modellnamen und der Produktnummer, die Sie auf dem Typenschild des Geräts finden. Siehe Kapitel „Gerätebeschreibung“.

Weitere Einzelheiten zur Energieplakette finden Sie auf [www.theenergylabel.eu](http://www.theenergylabel.eu).

### Link zur EU EPREL-Datenbank

Der QR-Code auf der Energieplakette des Geräts bietet einen Web-Link zur Registrierung des Geräts in der EU EPREL-Datenbank. Bewahren Sie daher die Energieplakette als Referenz zusammen mit dieser Bedienungsanleitung und allen anderen Unterlagen, die mit dem Gerät geliefert wurden, auf.

## Description de l'appareil

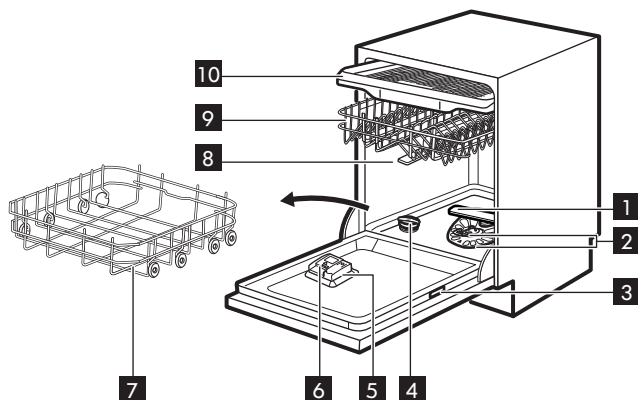

**1** Bras d'aspersion inférieur

**2** Filtres

**3** Plaque signalétique

**4** Réservoir de sel régénérant

**5** Distributeur de liquide de rinçage

**6** Distributeur de détergent

**7** Panier inférieur

**8** Bras d'aspersion supérieurs

**9** Panier supérieur

**10** Tiroir à couverts

### Beam-on-Floor

Beam-on-Floor s'affiche sur le sol, sous la porte de l'appareil.

- Lorsque le programme démarre, le faisceau blanc s'allume et reste allumé pendant toute la durée du programme.
- Lorsque le programme est terminé, le faisceau blanc disparaît.

- En cas de dysfonctionnement de l'appareil, le faisceau blanc clignote.



Le faisceau Beam-on-Floor s'éteint lorsque vous arrêtez l'appareil.

## Bandeau de commande

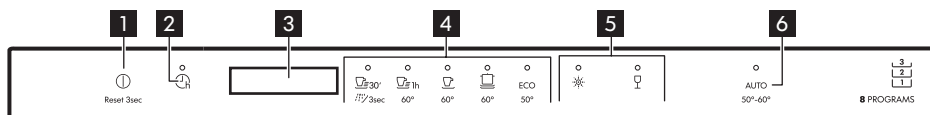

- 1** Touche Marche/Arrêt / Touche Réinitialiser
- 2** Touche Départ différé
- 3** Afficheur

- 4** Touches de programme
- 5** Touches Options
- 6** AUTO Touche de programme

## Afficheur

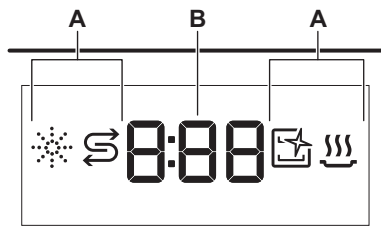

## A. Voyants

## B. Indication du temps





## Voyants

Voyant	Description
	Voyant du liquide de rinçage. Il s'allume lorsque le distributeur de liquide de rinçage doit être rempli.
	Voyant du sel de rinçage. Il s'allume lorsque le réservoir de sel régénérant doit être rempli.
	Voyant Machine Care. Il s'allume lorsque l'appareil nécessite un nettoyage interne avec le programme Machine Care.
	Voyant de phase de séchage. Il s'allume lorsque vous sélectionnez un programme avec la phase de séchage. Il clignote au cours de la phase de séchage.

## Présentation des programmes

Programme	Charge du lave-vaisselle	Degré de salissure	Température (°C)	Durée (min)	Options	AutoOpen
Quick 30'	Vaisselle, couverts	Salissure récente	50	30		✓
Rinse & Hold	Tous types de vaisselle	Tous degrés de salissure	Eau froide	15	X	X
60 Minutes	Vaisselle, couverts	Encrassement récent et légèrement sec	60	60		✓



Programme	Charge du lave-vaisselle	Degré de salissure	Température (°C)	Durée (min)	Options	AutoOpen
 <b>90 Minutes</b>	Vaisselle, couverts, casseroles et poêles	Encrassement normal et légèrement sec	60	90		✓
 <b>Intensive</b>	Vaisselle, couverts, casseroles et poêles	Encrassement normal à important et sec	60	160		✓
<b>ECO</b> 1)	Vaisselle, couverts, casseroles et poêles	Encrassement normal et légèrement sec	50	240		✓
<b>AUTO</b>	Vaisselle, couverts, casseroles et poêles	Tous	50 - 60	120 - 170	✗	✓
<b>Machine Care</b>	Nettoyage de l'intérieur de l'appareil. Se reporter à « Nettoyage et entretien ».		70	60	✗	✓

1) Ce programme vous permet d'optimiser votre consommation d'eau et d'énergie pour la vaisselle et les couverts normalement sales. Il s'agit du programme standard pour les instituts de tests. Ce programme permet d'évaluer la conformité avec la réglementation de la Commission (UE) 2019/2022 Ecodesign.

## Options

Vous pouvez ajuster le programme sélectionné en fonction de vos besoins en activant les options.

### Power Clean

 Power Clean améliore les résultats de lavage vaisselle du programme sélectionné. Cette option augmente la durée et la température de lavage.

### Gentle / Glass

 Gentle / Glass empêche la charge délicate, la verrerie en particulier, d'être endommagée. Cette option empêche les changements rapides de la température du lavage de la vaisselle du programme sélectionné, et la réduit à 45 °C.

## Réglages de base

Nu-méro	Réglage	Valeur de réglage	Dureté de l'eau	
			mmol/l	Degrés allemands (°dH)



<b>1</b>	Adoucisseur d'eau	10	8.4 - 9.0	47 - 50
		9	7.6 - 8.3	43 - 46
		8	6.5 - 7.5	37 - 42
		7	5.1 - 6.4	29 - 36
		6	4.0 - 5.0	23 - 28
		5 1)	3.3 - 3.9	19 - 22
		4	2.6 - 3.2	15 - 18
		3	1.9 - 2.5	11 - 14
		2	0.7 - 1.8	4 - 10
	1 2)	<0.7	<4	
<b>2</b>	Niv. liquide rinçage	0A - 8A		

3	Signal sonore de fin	1b (marche) / 0b (arrêt)
4	Ouverture automatique de la porte	1o (marche) / 0o (arrêt)
5	Tonalités des touches	1F (marche) / 0F (arrêt)
6	Sélection du dernier programme	1H (marche) / 0H (arrêt)





1) Réglages Usine.

2) N'utilisez pas de sel à ce niveau.

## Mode Configuration

Touche	Description
 1h	Départ/Pause Précédent. Appuyez pour naviguer entre les réglages de base et changer leurs valeurs.
	Départ/Pause OK. Appuyez pour accéder au réglage sélectionné et confirmer le changement de valeur.
	Départ/Pause Suivant. Appuyez pour naviguer entre les réglages de base et changer leurs valeurs.

## Comment modifier le réglage

- Maintenez simultanément les touches  30' et **ECO** enfoncées pendant environ 3 secondes pour accéder au mode réglage.
  - Les voyants :  1h,  et  sont allumés.
  - L'affichage indique la valeur actuelle du premier réglage disponible.
- Appuyez sur **Précédent** ou sur **Suivant** pour sélectionner le réglage.  
L'affichage indique la valeur actuelle du réglage (un chiffre et la lettre dédiée).
- Appuyez sur **OK** pour accéder au réglage.

La valeur actuelle clignote.

- Appuyez sur **Précédent** ou sur **Suivant** pour changer la valeur.
- Appuyez sur **OK** pour confirmer la valeur du réglage.
  - Le nouveau réglage est mémorisé.
  - L'appareil revient à la liste des réglages de base.
- Maintenez simultanément les touches  30' et **ECO** enfoncées pendant environ 3 secondes pour quitter le mode réglage.

L'appareil passe au mode de sélection de programme.

## AutoOpen

AutoOpen améliore le séchage tout en consommant moins d'énergie. Durant la phase de séchage, la porte s'ouvre automatiquement et reste entrouverte.

 **ATTENTION!** Ne tentez pas de refermer la porte de l'appareil dans les 2 minutes suivant son ouverture automatique. Cela pourrait endommager l'appareil.

 **ATTENTION!** Si des enfants, des animaux domestiques ou des personnes handicapées ont accès à l'appareil, désactivez AutoOpen. L'ouverture automatique de la porte peut présenter un danger et exposer des risques potentiels à l'intérieur de l'appareil (tels que couteaux, objets tranchants, produits chimiques).

## Avant la première utilisation

Assurez-vous que le niveau actuel de l'adoucisseur d'eau correspond à la dureté de l'arrivée d'eau.

Utilisez le programme Quick 30' pour éliminer tout résidu de fabrication.

- Versez 1 litre d'eau dans le réservoir de sel régénérant.
- Versez 1 kg de sel dans le réservoir de sel régénérant.

Utilisez uniquement du gros sel spécialement conçu pour les lave-vaisselle.

3. Remplissez le distributeur de liquide de rinçage.
4. Ouvrez le robinet d'arrivée d'eau.
5. Sélectionnez le programme Quick 30' et fermez la porte du lave-vaisselle pour le démarrer. N'utilisez pas de produit de lavage et laissez les paniers vides.



**ATTENTION!** De l'eau et du sel peuvent sortir du réservoir de sel régénérant lorsque vous le remplissez. Afin d'éviter la corrosion, lancez immédiatement un programme après avoir rempli le réservoir de sel régénérant.



Si vous n'utilisez pas l'appareil, fermez le robinet d'eau.

## Dépannage

Si vous rencontrez un problème avec votre appareil, consultez le chapitre « Dépannage » dans la version complète du

Manuel de l'utilisateur disponible sur : [www.ikea.com](http://www.ikea.com).

## Caractéristiques techniques

Type de produit	Lave-vaisselle parfaitement intégré	
Dimensions	Largeur / hauteur / profondeur (mm)	446 / 818 - 898 / 550
Branchement électrique <sup>1)</sup>	Tension (V)	220 - 240
	Fréquence (Hz)	50
Pression de l'arrivée d'eau	Min. / max. bar (MPa)	0.5 (0.05) / 10 (1.0)
Arrivée d'eau	Eau froide ou eau chaude <sup>2)</sup>	max. 60°C
Capacité	Configurations du nombre de couverts	10

1) Reportez-vous à la plaque signalétique pour d'autres valeurs.

2) Si l'eau chaude est produite à partir de sources d'énergie respectueuses de l'environnement (par exemple des panneaux solaires, énergie éolienne), utilisez une arrivée d'eau chaude afin de réduire la consommation d'énergie.

Il est possible de trouver des informations relatives aux performances du produit dans la base de données EPREL de l'EU grâce au lien <https://eprel.ec.europa.eu> avec le nom du modèle et le numéro de produit se trouvant sur la plaque signalétique de l'appareil. Reportez-vous au chapitre « Description du produit ».

Pour des informations plus détaillées sur l'étiquette énergétique, consultez le site [www.theenergylabel.eu](http://www.theenergylabel.eu).

## Lien vers la base de données EPREL de l'UE

Le code QR présent sur l'étiquette énergétique fournie avec l'appareil contient un lien Web permettant d'enregistrer cet appareil dans la base de données EPREL de l'UE. Conservez l'étiquette énergétique à titre de référence avec le manuel d'utilisation et tous les autres documents fournis avec cet appareil.

Pour télécharger la version complète, rendez-vous sur le site [www.ikea.com](http://www.ikea.com)

## Descrizione del prodotto

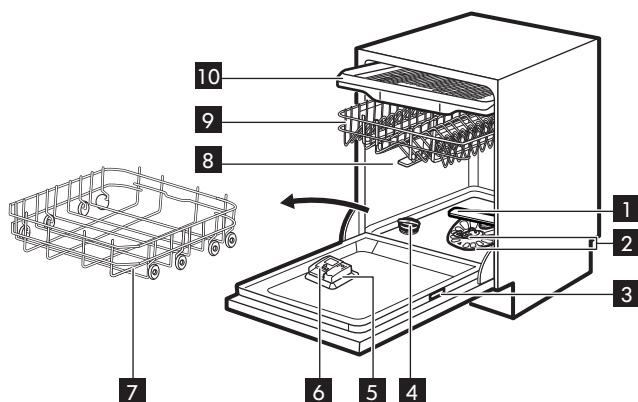

**1** Mulinello inferiore

**2** Filtri

**3** Targhetta identificativa

**4** Contenitore del sale

**5** Contenitore del brillantante

**6** Erogatore del detersivo

**7** Cestello inferiore

**8** Mulinelli superiori

**9** Cestello superiore

**10** Cassetto portaposate

### Beam-on-Floor

Beam-on-Floor è un fascio di luce mostrato sul pavimento al di sotto della porta dell'apparecchiatura.

- Quando un programma si avvia, la luce è bianca e rimane accesa per la durata del programma.

- A programma terminato, la luce bianca si spegne.
- Se l'apparecchiatura presenta un'anomalia, la luce bianca lampeggia.

**i** Beam-on-Floor si spegne con lo spegnimento dell'apparecchiatura.

## Pannello di controllo

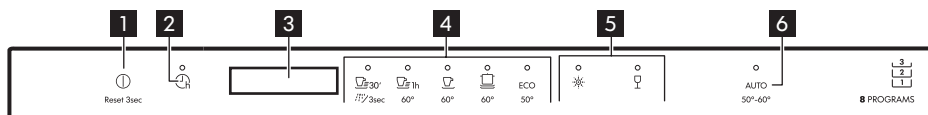

- 1 Tasto On/Off / Tasto reset
- 2 Tasto avvio ritardato
- 3 Display
- 4 Tasti programmi

- 5 Tasti Opzione
- 6 AUTO Tasto Programmi

### Display

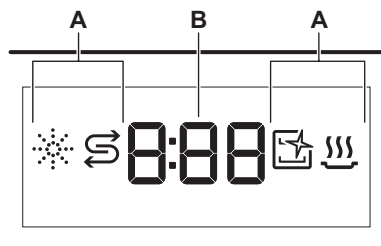

### B. Display dell'ora









#### Spie

Spia	Descrizione
	Spia brillantante. La spia è accesa quando è necessario ricaricare il contenitore del brillantante.
	Spia del sale. La spia è accesa quando è necessario ricaricare il contenitore del sale.
	Indicatore Machine Care. Si accende quando l'apparecchiatura necessita una pulizia interna col programma Machine Care.
	Indicatore Fase di asciugatura. È accesa quando è selezionato un programma con la fase di asciugatura. Lampeggia quando è in corso la fase di asciugatura.

### A. Spie

## Panoramica dei programmi

Programma	Carico lavastoviglie	Grado di sporco	Temperatura (°C)	Ora (min.)	Opzioni	AutoOpen
Quick 30'	Stoviglie, posate	Sporco fresco	50	30	 	✓
Rinse & Hold	Tutti i tipi di carico	Tutti i gradi di sporco	Acqua fredda	15	✗	✗
60 Minutes	Stoviglie, posate	Sporco fresco, leggermente essiccato	60	60	 	✓

Programma	Carico lavastoviglie	Grado di sporco	Temperatura (°C)	Ora (min.)	Opzioni	AutoOpen
 <b>90 Minutes</b>	Stoviglie, posate, pentole, padelle	Sporco normale, leggermente essiccato	60	90	 	✓
 <b>Intensive</b>	Stoviglie, posate, pentole, padelle	Sporco da normale a pesante, essiccato	60	160	 	✓
<b>ECO</b> <sup>1)</sup>	Stoviglie, posate, pentole, padelle	Sporco normale, leggermente essiccato	50	240	 	✓
<b>AUTO</b>	Stoviglie, posate, pentole, padelle	Tutte	50 - 60	120 - 170	✗	✓
<b>Machine Care</b>	Per la pulizia interna dell'apparecchiatura. Fare riferimento a "Pulizia e manutenzione".		70	60	✗	✓

1) Questo programma offre l'utilizzo più efficiente di acqua ed elettricità per lavare stoviglie e posate con grado di sporco normale. Questo è il programma standard per gli istituti di prova. Questo programma è utilizzato per valutare la conformità al regolamento della Commissione sulla progettazione ecocompatibile (UE) 2019/2022.

## Opzioni

Sarà possibile regolare la selezione del programma sulla base delle proprie esigenze attivando le opzioni.

### Power Clean

 Power Clean migliora i risultati di lavaggio del programma selezionato. Aumenta la temperatura e la durata del lavaggio.

### Gentle / Glass

 Gentle / Glass evita il danneggiamento del carico delicato, in particolare della cristalleria. L'opzione evita brusche variazioni della temperatura di lavaggio del programma selezionato e la riduce la temperatura a 45 °C.

## Impostazioni base



Numero	Impostazione	Valore dell'impostazione	Durezza dell'acqua	
			mmol/l	Gradi tedeschi (°dH)
1	Addolcitore dell'acqua	10	8.4 - 9.0	47 - 50
		9	7.6 - 8.3	43 - 46
		8	6.5 - 7.5	37 - 42
		7	5.1 - 6.4	29 - 36
		6	4.0 - 5.0	23 - 28
		5 <sup>1)</sup>	3.3 - 3.9	19 - 22
		4	2.6 - 3.2	15 - 18
		3	1.9 - 2.5	11 - 14
		2	0.7 - 1.8	4 - 10
		1 <sup>2)</sup>	<0.7	<4

2	Livello brillante	0A - 8A
3	Segnale di fine ciclo	1b (accensione) / 0b (spegnimento)
4	Apertura automatica	1o (accensione) / 0o (spegnimento)
5	Tono dei tasti	1F (accensione) / 0F (spegnimento)
6	Selezione ultimo programma	1H (accensione) / 0H (spegnimento)





1) Impostazioni di fabbrica.

2) Non usare sale a questo livello.

## Modalità di impostazione

Tasto	Descrizione
 1h	Tasto Precedente. Premere per spostarsi fra le impostazioni base e modificarne il valore.
	Tasto OK. Premere per accedere all'impostazione selezionata e per confermare la modifica del valore.
	Tasto Successivo. Premere per spostarsi fra le impostazioni base e modificarne il valore.

## Come modificare un'impostazione

- Per accedere alla modalità impostazione, tenere premuti contemporaneamente  30' e **ECO** per circa 3 secondi.
  - Le luci:  1h,  e  sono accese.
  - Il display mostra il valore attuale della prima impostazione disponibile.
- Premere **Precedente** o **Successivo** per selezionare l'impostazione.  
Il display mostra il valore di impostazione attuale (una cifra e la lettera dedicata).
- Premere **OK** per inserire l'impostazione. Il valore impostazione attuale lampeggia.
- Premi **Precedente** o **Successivo** per modificare il valore.
- Premere **OK** per confermare il valore dell'impostazione.
  - Viene salvato il nuovo valore dell'impostazione.
  - L'apparecchiatura torna all'elenco impostazioni di base.

- Per uscire dalla modalità impostazione tenere premuti contemporaneamente  30' e **ECO** per circa 3 secondi. L'apparecchiatura passa alla selezione del programma.

## AutoOpen

AutoOpen migliora i risultati di asciugatura con consumi elettrici ridotti. Lo sportello si apre automaticamente durante la fase di asciugatura e resta socchiuso.

 **ATTENZIONE!** Non cercare di chiudere lo sportello dell'apparecchiatura 2 minuti dopo l'apertura automatica. Questo può danneggiare l'apparecchiatura.

 **ATTENZIONE!** Se bambini, animali domestici o persone con disabilità hanno accesso all'apparecchiatura, disattivare AutoOpen. L'apertura automatica della porta può rappresentare un pericolo ed esporre l'apparecchiatura a possibili pericoli (come coltelli, oggetti taglienti, sostanze chimiche).

## Prima del primo utilizzo

Assicurarsi che il livello corrente dell'addolcitore dell'acqua corrisponda alla durezza dell'alimentazione dell'acqua.

Utilizzare il programma Quick 30' per rimuovere i residui dal processo di fabbricazione.

- Versare 1 litro di acqua nel contenitore del sale.
- Mettere 1 kg di sale nel contenitore del sale.  
Usare sale grosso specifico per lavastoviglie.
- Riempire la vaschetta del brillantante.
- Aprire il rubinetto dell'acqua.

- Selezionare il programma Quick 30' e chiudere la porta della lavastoviglie per avviarla. Non usare detersivo e non mettere i piatti nei cestelli.

 **ATTENZIONE!** Acqua e sale possono fuoriuscire dal contenitore del sale durante il riempimento. Dopo aver riempito il contenitore del sale, avviare immediatamente un programma volto ad evitare la corrosione.

-  Se non si utilizza l'apparecchiatura, chiudere il rubinetto dell'acqua.

## Risoluzione dei problemi

In caso di problemi con l'apparecchiatura consultare il capitolo "Risoluzione dei problemi" nella versione completa del

Manuale d'uso disponibile su:  
[www.ikea.com](http://www.ikea.com).

## Informazioni tecniche

Tipo di prodotto	Lavastoviglie completamente integrata	
Dimensioni	Larghezza / altezza / profondità (mm)	446 / 818 - 898 / 550
Collegamento elettrico <sup>1)</sup>	Tensione (V)	220 - 240
	Frequenza (Hz)	50
Pressione di alimentazione dell'acqua	Min./max. bar (Mpa)	0,5 (0,05) / 10 (1,0)
Collegamento dell'acqua	Acqua fredda o acqua calda <sup>2)</sup>	max 60°C
Capacità	Coperti	10

Per informazioni dettagliate sull'etichetta energetica, vedere [www.theenergylabel.eu](http://www.theenergylabel.eu).

*1) Fare riferimento alla targhetta dei dati per altri valori.*

*2) Consigliamo il collegamento all'acqua calda se prodotta mediante utilizzo di una fonte di energia alternativa (per es. pannelli solari, energia eolica) per ridurre il consumo energetico.*

### Collegamento alla banca dati EPREL dell'UE

Il codice QR sull'etichetta energetica fornita con l'apparecchio fornisce un link web per la registrazione di questo apparecchio nella banca dati EPREL dell'UE. Conservare l'etichetta energetica come riferimento insieme al manuale d'uso e a tutti gli altri documenti forniti con questo apparecchio.

È possibile trovare le stesse informazioni correlate alle prestazioni del prodotto nella banca dati EPREL dell'UE utilizzando il link <https://eprel.ec.europa.eu> e il nome del modello e il numero di prodotto che si trovano sulla targhetta dell'apparecchio. Vedere il capitolo "Descrizione del prodotto".



## Descrição do produto

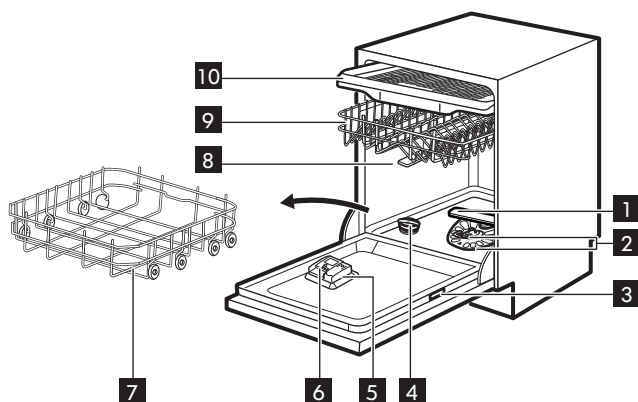

**1** Braço aspersor inferior

**2** Filtros

**3** Placa de classificação

**4** Depósito de sal

**5** Distribuidor de abrillantador

**6** Distribuidor de detergente

**7** Cesto inferior

**8** Braços aspersores superiores

**9** Cesto superior

**10** Gaveta de talheres

### Beam-on-Floor

Beam-on-Floor é uma luz que é projetada no chão, por baixo da porta do aparelho.

- Quando um programa inicia, aparece uma luz branca que permanece acesa durante todo o programa.

- Quando o programa termina, a luz branca desaparece.
- Quando o aparelho tem uma anomalia, a luz branca fica intermitente.

**i** Beam-on-Floor apaga-se quando o aparelho é desativado.

## Painel de controlo

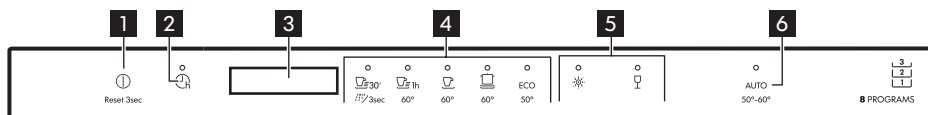

- 1** Botão ligar/desligar/Botão de Reset
- 2** Botão de Início Diferido
- 3** Visor
- 4** Botões de programa

- 5** Botão de opções
- 6** AUTO Botão de programa

### Visor

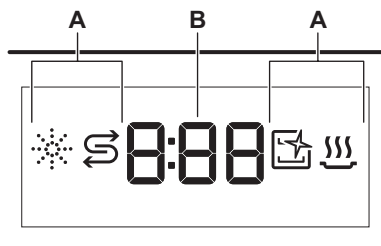

#### A. Indicadores









#### B. Indicador da hora

### Indicadores

Indicador	Do ciclo
	Indicador de abrillantador. Está aceso quando o dispensador de abrillantador necessita de ser reabastecido.
	Indicador de falta de sal. Está aceso quando o recipiente do sal necessita de ser reabastecido.
	Indicador Machine Care. Está aceso quando a máquina necessita de limpeza interna com o programa Machine Care.
	Indicador da fase de secagem. Está aceso quando está selecionado o programa com fase de secagem. Pisca quando a fase de secagem está em curso.

## Visão geral de programas

Programa	Carga de máquina de lavar louça	Nível de sujidade	Temperatura (°C)	Tempo (min)	Opções	AutoOpen
 Quick 30'	Loiça, talheres	Sujidade recente	50	30	 	✓
 Rinse & Hold	Todos os tipos de carga	Todos os níveis de sujidade	Água fria	15	✗	✗
 60 Minutes	Loiça, talheres	Sujidade fresca, ligeiramente seca	60	60	 	✓

Programa	Carga de máquina de lavar loiça	Nível de sujidade	Temperatura (°C)	Tempo (min)	Opções	AutoOpen
 <b>90 Minutes</b>	Loiça, talheres, tachos, panelas	Sujidade normal, ligeiramente seca	60	90	 	✓
 <b>Intensive</b>	Loiça, talheres, tachos, panelas	Sujidade normal a intensa, seca	60	160	 	✓
<b>ECO</b> <sup>1)</sup>	Loiça, talheres, tachos, panelas	Sujidade normal, ligeiramente seca	50	240	 	✓
<b>AUTO</b>	Loiça, talheres, tachos, panelas	Todas	50 - 60	120 - 170	✗	✓
<b>Machine Care</b>	Para limpar o interior do aparelho. Consulte "Limpeza e Manutenção".		70	60	✗	✓

1) Com este programa, terá os consumos de água e energia mais eficientes para loiça e talheres com sujidade normal. Este é o programa padrão para institutos de testes. Este programa é utilizado para avaliar a conformidade com o Regulamento de Ecodesign da Comissão (UE) 2019/2022.

### Opções

Pode regular a seleção de programa para as suas necessidades ativando as opções.

#### Power Clean

 Power Clean melhora os resultados de lavagem do programa selecionado. A opção aumenta a temperatura e a duração da lavagem.

#### Gentle / Glass

 Gentle / Glass evita que a carga delicada, em particular os copos, fique danificada. A opção previne mudanças rápidas na temperatura de lavagem do programa selecionado e redu-las a 45 °C.

## Definições de base



Número	Definição	Valor de definição	Dureza da água	
			mmol/l	Graus alemães (°dH)
1	Amaciador de água	10	8.4 - 9.0	47 - 50
		9	7.6 - 8.3	43 - 46
		8	6.5 - 7.5	37 - 42
		7	5.1 - 6.4	29 - 36
		6	4.0 - 5.0	23 - 28
		5 <sup>1)</sup>	3.3 - 3.9	19 - 22
		4	2.6 - 3.2	15 - 18
		3	1.9 - 2.5	11 - 14
		2	0.7 - 1.8	4 - 10
		1 <sup>2)</sup>	<0.7	<4
2	Nível de abrihantador	0A - 8A		

3	Indicador de fim	1b (ligado) / 0b (desligado)
4	Abrir porta auto.	1o (ligado) / 0o (desligado)
5	Sons "teclado"	1F (ligado) / 0F (desligado)
6	Última seleção de programa	1H (ligado) / 0H (desligado)

1) Definição de fábrica.





2) Não utilize sal neste nível.

### Modo de configuração

Botão	Do ciclo
 1h	Botão Anterior. Prima para alternar entre as definições básicas e para alterar os seus valores.
	Botão OK. Prima para entrar na definição selecionada e para confirmar a alteração do seu valor.

Botão	Do ciclo
	Botão Seguinte. Prima para alternar entre as definições básicas e para alterar os seus valores.

### Como alterar uma definição

- Para entrar no modo de definição, prima simultaneamente  30' e **ECO** durante cerca de 3 segundos.
  - Luzes:  1h,  e  estão ligados.
  - O visor apresenta o valor atual da primeira definição disponível.
- Prima **Anterior** ou **Seguinte** para selecionar a definição.  
O visor exibe o valor da definição atual (um dígito e uma letra dedicada).
- Prima **OK** para introduzir a definição.  
O valor da definição atual fica intermitente.
- Prima **Anterior** ou **Seguinte** para alterar o valor.
- Prima **OK** para confirmar o valor da definição.
  - O novo valor de definição é guardado.
  - O aparelho volta à lista de definições básicas.
- Prima simultaneamente  30' e **ECO** durante cerca de 3 segundos para sair do modo de definição.

O aparelho muda para a seleção de programa.

### AutoOpen

AutoOpen melhora a secagem e reduz o consumo de energia. A porta do aparelho abre automaticamente durante a fase de secagem e permanece entreaberta.

 **CUIDADO!** Não tente fechar a porta do aparelho durante os primeiros 2 minutos após a abertura automática. Isso pode danificar o aparelho.

 **CUIDADO!** Se crianças, animais de estimação ou pessoas com deficiência tiverem acesso ao aparelho, desative AutoOpen. A abertura automática da porta pode representar um perigo e expor possíveis perigos no interior do aparelho (tais como facas, objetos afiados, produtos químicos).

## Antes da primeira utilização

Certifique-se de que o nível atual do descalcificador de água está ajustado para a dureza da água fornecida.

Utilize o programa Quick 30' para remover resíduos do processo de fabrico.

- Coloque 1 litro de água no depósito de sal.
- Coloque 1 kg de sal no depósito de sal. Utilize apenas sal grosso especial para máquinas de lavar loiça.
- Encha o distribuidor de abrilhantador.
- Abra a torneira da água.
- Selecione o programa Quick 30' e feche a porta para o iniciar. Não use detergente e não coloque pratos nos cestos.

 **CUIDADO!** É possível que saia água e sal do depósito de sal quando estiver a enchê-lo. Após encher o depósito de sal, inicie imediatamente um programa para evitar corrosão.

 Se não utilizar o aparelho, feche a torneira de água.

## Resolução de problemas

Se tiver um problema com o seu aparelho, consulte o capítulo "Resolução de

problemas" na versão completa do Manual do Utilizador disponível em: [www.ikea.com](http://www.ikea.com).

## Informação técnica

Tipo de produto	Máquina de lavar loiça totalmente encastrável	
Dimensões	Largura / Altura / Profundidade (mm)	446 / 818 - 898 / 550
Ligação elétrica <sup>1)</sup>	Tensão (V)	220 - 240
	Frequência (Hz)	50
Pressão do fornecimento de água	Bar mín./máx. (MPa)	0.5 (0.05) / 10 (1.0)
Fornecimento de água	Água fria ou água quente <sup>2)</sup>	máx. 60 °C
Capacidade	Definições de colocação	10

1) Consulte a placa de classificação para conhecer os outros valores.

2) Se a água quente for proveniente de fontes de energias renováveis (p. ex., painéis solares, energia eólica), utilize o fornecimento de água quente para diminuir o consumo de energia.

### Link para a base de dados de EU EPREL

O código QR no rótulo energético fornecido com o aparelho disponibiliza um link da web para o registo deste aparelho na base de dados da EU EPREL. Mantenha a etiqueta de energia para consulta juntamente com o manual do utilizador e todos os outros documentos disponibilizados com este aparelho.

É possível encontrar informação relacionada com o desempenho do produto na base de dados de EU EPREL utilizando o link <https://eprel.ec.europa.eu> e o nome do modelo e número do produto que pode encontrar na placa de características do aparelho. Consulte o capítulo "Descrição do produto".

Para informação mais detalhada sobre a etiqueta de energia, visite [www.theenergylabel.eu](http://www.theenergylabel.eu).

## Descripción del producto

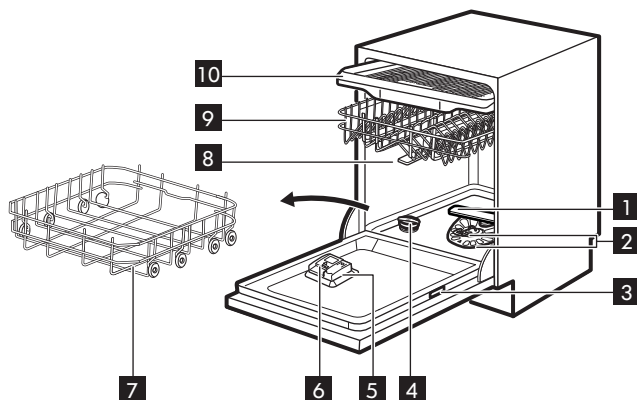

**1** Brazo aspersor inferior

**2** Filtros

**3** Placa de características técnicas

**4** Depósito de sal

**5** Dosificador de abrillantador

**6** Dosificador de detergente

**7** Cesto inferior

**8** Brazos aspersores intermedios

**9** Cesto superior

**10** Cajón de cubiertos

### Beam-on-Floor

Beam-on-Floor es una luz que aparece en el suelo bajo la puerta del aparato.

- Cuando empieza el programa, la luz blanca se enciende y permanece encendida durante el programa.

- Una vez completado el programa, se apaga la luz blanca.

- Cuando el aparato presenta una avería, la luz blanca parpadea.

**i** Beam-on-Floor desaparece cuando se desactiva el aparato.

## Panel de mandos

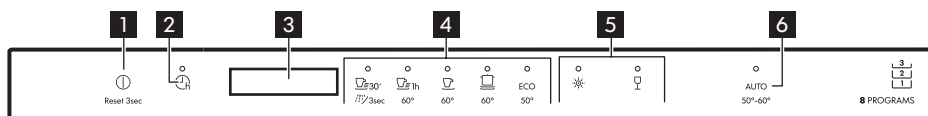

- 1** Botón de encendido/apagado / Botón de reinicio
- 2** Botón de inicio diferido
- 3** Pantalla
- 4** Botones de programa
- 5** Teclas de opciones
- 6** Botón de programa AUTO

## Pantalla

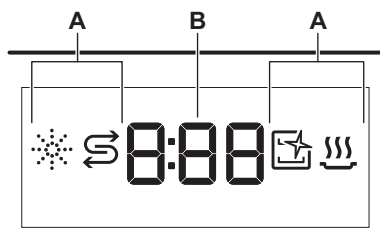



- A.** Indicadores
- B.** Indicador de tiempo

## Indicadores

Indicador	Descripción
	Indicador de abrillantador. Se enciende cuando hay que rellenar el dosificador de abrillantador.
	Indicador de sal. Se enciende cuando hay que rellenar el depósito de sal.
	Indicador Machine Care. Se enciende cuando el aparato necesita una limpieza interna con el programa Machine Care.
	Indicador de fase de secado. Se activa cuando se selecciona un programa con la fase de secado. Parpadea durante la fase de secado.

## Resumen de los programas

Programa	Carga del lavavajillas	Grado de suciedad	Temperatura (°C)	Hora (m)	Opciones	AutoOpen
 Quick 30'	Vajilla, cubertería	Suciedad reciente	50	30	 	✓
 Rinse & Hold	Todo tipo de carga	Todos los grados de suciedad	Agua fría	15	<b>X</b>	<b>X</b>
 60 Minutes	Vajilla, cubertería	Residuos de comida frescos y ligeramente secos	60	60	 	✓
 90 Minutes	Vajilla, cubiertos, ollas y sartenes	Residuos de comida normales, ligeramente secos	60	90	 	✓

Programa	Carga del lavavajillas	Grado de suciedad	Temperatura (°C)	Hora (m)	Opciones	AutoOpen
 <b>Intensive</b>	Vajilla, cubiertos, ollas y sartenes	Residuos de comida de normales a pesados, secos	60	160		✓
<b>ECO</b> <sup>1)</sup>	Vajilla, cubiertos, ollas y sartenes	Residuos de comida normales, ligeramente secos	50	240		✓
<b>AUTO</b>	Vajilla, cubiertos, ollas y sartenes	Todo	50 - 60	120 - 170	✗	✓
<b>Machine Care</b>	Limpieza del interior del aparato. Consulte "Limpieza y mantenimiento".		70	60	✗	✓

1) Este programa ofrece el uso más eficaz en cuanto al consumo de agua y energía para vajillas y cubiertos con suciedad normal. Este es el programa estándar para institutos de pruebas. Este programa se utiliza para evaluar el cumplimiento del Reglamento de la Comisión sobre ecodiseño (UE) 2019/2022.

### Opciones

Puede ajustar la selección de programas a sus necesidades activando opciones.

#### Power Clean

 Power Clean mejora los resultados de lavado del programa seleccionado. Esta opción aumenta la temperatura y la duración del lavado.

#### Gentle / Glass

 Gentle / Glass evita cualquier daño en cargas delicadas, en particular las piezas de cristal. La opción evita cambios rápidos en la temperatura del programa seleccionado y la reduce a 45 °C.

## Ajustes básicos



Número	Ajuste	Valor de ajuste	Dureza del agua	
			mmol/l	Grados alemanes (°dH)
1	Descalcificador de agua	10	8.4 - 9.0	47 - 50
		9	7.6 - 8.3	43 - 46
		8	6.5 - 7.5	37 - 42
		7	5.1 - 6.4	29 - 36
		6	4.0 - 5.0	23 - 28
		5 <sup>1)</sup>	3.3 - 3.9	19 - 22
		4	2.6 - 3.2	15 - 18
		3	1.9 - 2.5	11 - 14
		2	0.7 - 1.8	4 - 10
2	Nivel de ablandador	0A - 8A		
		1 <sup>2)</sup>	<0.7	<4

3	Sonido de fin	1b ON (activado) / 0b OFF (desactivado)
4	Apertura puerta auto.	1o ON (activado) / 0o OFF (desactivado)
5	Tono de teclas	1F ON (activado) / 0F OFF (desactivado)
6	Última selección de programa	1H ON (activado) / 0H OFF (desactivado)

1) Ajustes de fábrica.

2) No utilice sal en este nivel.





### Modo de ajuste

Tecla	Descripción
 1h	Botón Anterior. Púlsalo para cambiar entre los ajustes básicos y para modificar su valor.
	Botón ACEPTAR. Púlsalo para introducir el ajuste seleccionado y confirmar el cambio de valor.



Tecla	Descripción
	Botón Siguiente. Púlsalo para cambiar entre los ajustes básicos y para modificar su valor.

### Cómo cambiar un ajuste

- Mantén pulsados simultáneamente  30' y **ECO** durante unos 3 segundos para acceder al modo de ajuste.
  - Los indicadores luminosos:  h,  y  están encendidos.
  - La pantalla muestra el valor actual del primer ajuste disponible.
- Pulsa **Anterior** o **Siguiente** para seleccionar el ajuste.  
La pantalla muestra el valor de ajuste actual (un dígito y la letra correspondiente).
- Pulsa **ACEPTAR** para introducir el ajuste. El valor de ajuste actual parpadea.
- Pulsa **Anterior** o **Siguiente** para cambiar el valor.
- Pulsa **ACEPTAR** para confirmar el valor de ajuste.
  - El nuevo valor de ajuste se ha guardado.
  - El aparato vuelve a la lista de ajustes básica.
- Mantén pulsados simultáneamente  30' y **ECO** durante unos 3 segundos para salir del modo de ajuste.

El aparato cambia a la selección de programas.

### AutoOpen

AutoOpen mejora el resultado de secado con menos consumo de energía. La puerta del aparato se abre automáticamente durante la fase de secado y permanece entreabierta.

 **PRECAUCIÓN!** No intente cerrar la puerta del aparato durante 2 minutos después de la apertura automática. Podría dañar el aparato.

 **PRECAUCIÓN!** Si los niños, mascotas o personas con discapacidades tienen acceso al aparato, desactiva AutoOpen. La apertura automática de la puerta puede suponer un peligro y quedar también expuestos posibles peligros dentro del aparato (como cuchillos, objetos afilados o productos químicos).

## Antes del primer uso

Asegúrese de que el ajuste actual del descalcificador de agua se adecúa a la dureza del agua utilizada.

Use el programa Quick 30' para eliminar los residuos del proceso de fabricación.

- Vierta 1 litro de agua en el depósito de sal.
- Ponga 1 kg de sal en el depósito de sal. Utilice solo sal gruesa diseñada para lavavajillas.
- Llenado del dosificador de abrillantador.
- Abra el grifo.
- Seleccione el programa Quick 30' y cierre la puerta del lavavajillas para iniciarlo.

No utilice detergente ni cargue platos en los cestos.

 **PRECAUCIÓN!** El agua y la sal pueden salirse del depósito de sal cuando lo llena. Después de llenar el depósito de sal, inicie inmediatamente un programa para evitar la corrosión.

 Si no utiliza el aparato, cierre el grifo de agua.

## Solución de problemas

Si tiene algún problema con el aparato, consulte el capítulo "Solución de problemas"

en la versión completa del manual del usuario disponible en: [www.ikea.com](http://www.ikea.com).

## Información técnica

Tipo de producto	Lavavajillas totalmente integrado	
Dimensiones	Ancho / alto / fondo (mm)	446 / 818 - 898 / 550
Conexión eléctrica 1)	Tensión (V)	220 - 240
	Frecuencia (Hz)	50
Presión del suministro de agua	Mín. / máx. bares (Mpa)	0.5 (0.05) / 10 (1.0)
Suministro de agua	Agua fría o caliente 2)	máx. 60°C
Capacidad	Coloque los cubiertos	10

1) Consulte la placa de datos técnicos para otros valores.

2) Si el agua caliente procede de una fuente de energía alternativa (por ejemplo, paneles solares o energía eólica), utilice la toma de agua caliente para reducir el consumo de energía.

### Enlace a la base de datos EPREL de la UE

El código QR de la etiqueta energética suministrada con el aparato proporciona un enlace web para el registro de este aparato en la base de datos de EU EPREL. Guarde la etiqueta de energía como referencia junto con el manual de usuario y todos los demás documentos que se proporcionan con este aparato.

Es posible encontrar información relacionada con el rendimiento del producto en la base de datos EPREL de la UE utilizando el enlace <https://eprel.ec.europa.eu> y el nombre del modelo y el número de producto que se encuentra en la placa de características del aparato. Consulte el capítulo "Descripción del producto".

Para obtener información más detallada sobre la etiqueta energética, visite [www.theenergylabel.eu](http://www.theenergylabel.eu).

Productbeschrijving

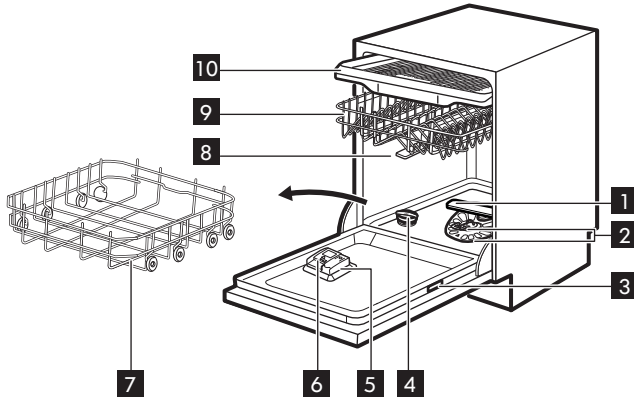

- 1 Onderste sproeiarm
- 2 Filters
- 3 Typeplaatje
- 4 Zoutreservoir
- 5 Glansmiddeldoseerbakje
- 6 Afwasmiddeldoseerbakje

- 7 Onderste korf
- 8 Bovenste sproeiarmen
- 9 Bovenste korf
- 10 Besteklade

**Beam-on-Floor**

Beam-on-Floor is licht dat onder de deur van het apparaat op de vloer wordt weergegeven.

- Wanneer het programma start, gaat er een wit licht aan en blijft gedurende het volledige programma zichtbaar.

- Als het programma klaar is, gaat het witte licht uit.
- Als er een storing in het apparaat optreedt, gaat het witte licht knipperen.

**i** De Beam-on-Floor gaat uit wanneer het apparaat wordt uitgeschakeld.

## Bedieningspaneel

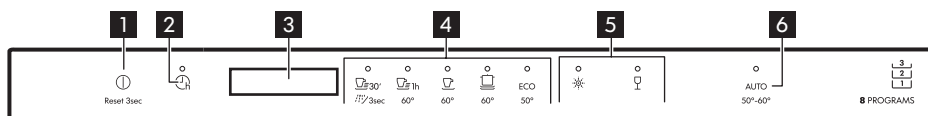

- 1 Aan-/uittoets/Resettoets
- 2 Toets uitgestelde start
- 3 Display
- 4 Programma-toetsen

- 5 Optietoetsen
- 6 AUTO programmattoetsen

### Display

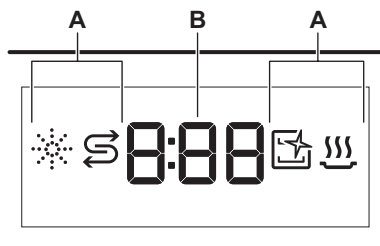

### B. Indicatielampje tijd









#### Indicatielampjes

Indicatie-lampje	Beschrijving
	Indicatielampje glansspoelmiddel. Dit is aan als het glansspoelmiddeldoseerbakje bijge-vuld dient te worden.
	Indicatielampje zout. Dit is aan als het zout-reservoir bijge-vuld dient te worden.
	Indicatielampje Machine Care. Dit is aan als het apparaat interne reiniging nodig heeft met het Machine Care-programma.
	Controlelampje droogfase. Dit is aan als een programma met droogfase is gekozen. Het gaat knipperen wanneer de droogfase loopt.

### A. Indicatielampjes

## Programmaoverzicht

Programma	Lading vaatwas-ser	Mate van bevui-ling	Temperatuur (°C)	Tijd (min)	Opties	AutoOpen
 Quick 30'	Serviesgoed, be-stek	Recente bevui-ling	50	30	 	✓
 Rinse & Hold	Alle soorten la-ding	Alle vuilgraden	Koud water	15	X	X
 60 Minutes	Serviesgoed, be-stek	Vers, licht opge-droogd vuil	60	60	 	✓

Programma	Lading vaatwaser	Mate van bevuiding	Temperatuur (°C)	Tijd (min)	Opties	AutoOpen
 <b>90 Minutes</b>	Serviesgoed, bestek, potten, pannen	Normaal, licht gedroogd op vuil	60	90	 	✓
 <b>Intensive</b>	Serviesgoed, bestek, potten, pannen	Normaal tot grondig, volledig gedroogd	60	160	 	✓
<b>ECO</b> <sup>1)</sup>	Serviesgoed, bestek, potten, pannen	Normaal, licht gedroogd op vuil	50	240	 	✓
<b>AUTO</b>	Serviesgoed, bestek, potten, pannen	Alles	50 - 60	120 - 170	✗	✓
<b>Machine Care</b>	Voor het reinigen van de binnenkant van het apparaat. Zie "Reiniging en onderhoud".		70	60	✗	✓

1) Dit programma heeft het meest efficiënte water- en energieverbruik voor normaal vervuild serviesgoed en bestek. Dit is het standaardprogramma voor testinstituten. Dit programma wordt gebruikt voor de beoordeling van de naleving van Verordening (EU) 2019/2022 van de Commissie inzake ecologisch ontwerp.

### Opties

U kunt de programmakeuze aanpassen aan uw behoeften door opties te activeren.

#### Power Clean

 Power Clean verbetert de vaatwasresultaten van het geselecteerde programma. De optie verhoogt de wastemperatuur en verlengt de duur.

#### Gentle / Glass

 Gentle / Glass voorkomt dat delicate ladingen, met name glaswerk, beschadigen. De optie voorkomt snelle wijzigingen in de vaatwastemperatuur van het gekozen programma en verlaagt het naar 45 °C.

## Basisinstellingen



Aantal	Instellingen	Waarde instellen	Waterhardheid	
			mmol/l	Duitse hardheid (°dH)
1	Waterontharder	10	8.4 - 9.0	47 - 50
		9	7.6 - 8.3	43 - 46
		8	6.5 - 7.5	37 - 42
		7	5.1 - 6.4	29 - 36
		6	4.0 - 5.0	23 - 28
		5 <sup>1)</sup>	3.3 - 3.9	19 - 22
		4	2.6 - 3.2	15 - 18
		3	1.9 - 2.5	11 - 14
		2	0.7 - 1.8	4 - 10
		1 <sup>2)</sup>	<0.7	<4

2	Niveau glansspoelmiddel	0A - 8A
3	Geluid stoppen	1b (aan) / 0b (uit)
4	Aut. deuropening	1o (aan) / 0o (uit)
5	Toetstonen	1F (aan) / 0F (uit)
6	Laatste programmakeuze	1H (aan) / 0H (uit)

1) Fabrieksinstelling.

2) Gebruik geen zout op dit niveau.

**Instillingsmodus**

Toets	Beschrijving
 1h	Vorige-toets. Druk om te schakelen tussen de basisinstellingen en om hun waarde te wijzigen.
	OK-toets. Druk om in de gekozen instelling te gaan en de gewijzigde waarde hiervan te bevestigen.
	Volgende-toets. Druk om te schakelen tussen de basisinstellingen en om hun waarde te wijzigen.

**Een instelling wijzigen**

- Om de instellingenmodus in te gaan, druk je tegelijkertijd op  30' en **ECO** en houd je die ongeveer 3 seconden vast.
  - De verlichting:  1h,  en  zijn ingeschakeld.
  - Het display toont de huidige waarde van de eerste beschikbare instelling.
- Druk op **Vorige** of **Volgende** om de instelling te selecteren.  
Het display toont de huidige instellingswaarde (een cijfer en de speciale letter).
- Druk op **OK** om de instelling te bevestigen.  
De huidige instelling knippert.
- Druk op **Vorige** of **Volgende** om de waarde te veranderen.
- Druk op **OK** om de instellingswaarde te bevestigen.
  - De nieuwe instellingswaarde wordt opgeslagen.

- Het apparaat keert terug naar de basisinstellingenlijst.
- Druk tegelijkertijd op  30' en **ECO** en houd ze ongeveer 3 seconden ingedrukt om de instellingsmodus te verlaten.  
Het apparaat schakelt over naar de programmakeuze.

**AutoOpen**

AutoOpen biedt goede droogresultaten met minder energieverbruik. Tijdens de droogfase opent de deur van het apparaat automatisch en blijft deze op een kier staan.

-  **Let op!** Probeer de deur van het apparaat niet binnen twee minuten na automatisch openen te sluiten. Dit kan het apparaat beschadigen.
-  **Let op!** Als kinderen, huisdieren of mensen met een handicap toegang hebben tot het apparaat, schakel je AutoOpen uit. Het automatisch openen van de deur kan een gevaar vormen en mogelijke gevaren in het apparaat blootstellen (zoals messen, scherpe voorwerpen, chemicaliën).

**Voorafgaand aan het eerste gebruik**

Zorg ervoor dat het stroomniveau van de waterontharder is aangepast aan de hardheid van de watertoevoer.  
Gebruik het programma Quick 30' om resten uit het productieproces te verwijderen.

- Giet 1 liter water in het zoutreservoir.
- Doe 1 kg zout in het zoutreservoir.  
Gebruik uitsluitend grof zout dat voor vaatwassers is gemaakt.
- Vul het glansmiddeldoseerbakje.
- Open de waterkraan.

- Selecteer het programma Quick 30' en sluit de deur van de vaatwasser om deze te starten. Gebruik geen afwasmiddel en plaats geen vaat in de korven.
  -  **Let op!** Water en zout kunnen uit het zoutreservoir stromen als u het bijvult. Start na het bijvullen van het zoutreservoir onmiddellijk een programma om corrosie te voorkomen.

-  Als je het apparaat niet gebruikt, sluit dan de waterkraan.

## Probleemoplossing

Als u op een probleem met uw apparaat stuit, raadpleeg dan het hoofdstuk "Probleemoplossing" in de volledige versie

van de gebruikershandleiding, beschikbaar op: [www.ikea.com](http://www.ikea.com).

## Technische informatie

Producttype	Volledig geïntegreerde vaatwasser	
Afmetingen	Breedte / hoogte / diepte (mm)	446 / 818 - 898 / 550
Elektrische aansluiting <sup>1)</sup>	Spanning (V)	220 - 240
	Frequentie (Hz)	50
Watertoevoerdruk	Min. / max. bar (MPa)	0,5 (0.05) / 10 (1.0)
Watertoevoer	Koud water of warm water <sup>2)</sup>	max. 60°C
Capaciteit	Plaatsinstellingen	10

1) Zie het typeplaatje voor andere waarden.

2) Als het hete water door een alternatieve energiebron wordt geproduceerd (bijv. zonnepanelen, eolische energie), gebruik dan de heetwatervoorziening om het energieverbruik te verminderen.

### Link naar de EU-EPREL-databank

De QR-code op het energielabel dat bij het apparaat wordt geleverd, biedt een weblink naar de registratie van dit apparaat in de EU-EPREL-database. Bewaar het energielabel ter referentie samen met de gebruikershandleiding en alle andere documenten die bij dit apparaat worden geleverd.

Het is ook mogelijk om informatie gerelateerd aan de prestaties van het product in de EU-EPREL-databank te vinden via de link <https://eprel.ec.europa.eu> en de modelnaam en het productnummer kunt u vinden op het typeplaatje van het apparaat. Zie het hoofdstuk 'Productbeschrijving'.

Kijk voor meer informatie over het energielabel op [www.theenergylabel.eu](http://www.theenergylabel.eu)

## Produktbeskrivelse

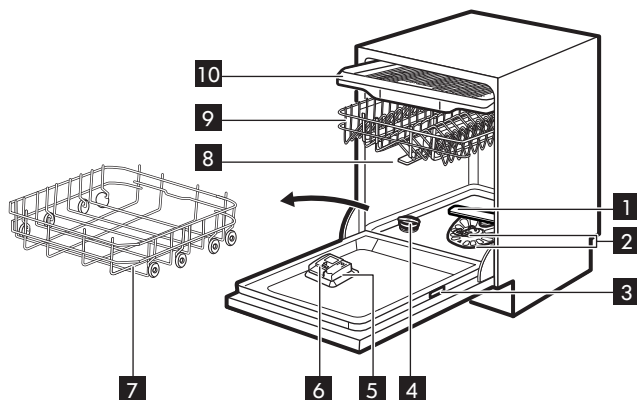

- 1** Nederste spulearm
- 2** Filtre
- 3** Typeskilt
- 4** Saltbeholder
- 5** Kammer til afspændingsmiddel
- 6** Opvaskemiddeldispenser

- 7** Nederste kurv
- 8** Øverste spulearme
- 9** Øverste kurv
- 10** Bestikskuffe

### Beam-on-Floor

Beam-on-Floor er en lampe på gulvet under apparatets låge.

- Når et program starter, tændes den hvide lampe og forbliver tændt under hele programmet.

- Når programmet er afsluttet, slukkes det hvide lys.
- Når der er en fejl på maskinen, blinker det hvide lys.

**i** Beam-on-Floor slukkes, når maskinen slukkes.



## Kontrolpanel

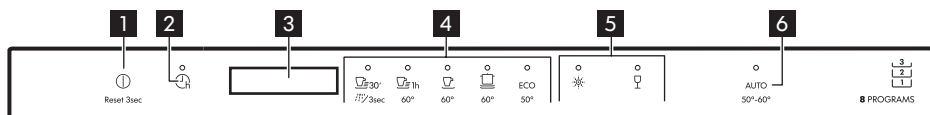

**1** Tænd-/sluk-knap/Nulstillingsknap

**2** Senere start-knap

**3** Display

**4** Programknapper

**5** Tilvalgsknapper

**6** AUTO-programknap

## Display

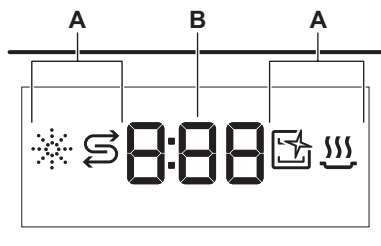

## B. Lampe for tid





### Kontrollamper

Kontrollampe	Beskrivelse
	Lampe for afspændingsmiddel. Lyser, når kammeret til afspændingsmiddel skal genfyldes.
	Kontrollampe for salt. Er tændt, når saltbeholderen skal genfyldes.
	Machine Care-lampe Den er tændt, når apparatet har brug for indvendig rengøring med Machine Care-programmet.
	Kontrollampe for tørrefase. Den er tændt, når du vælger et program med tørrefasen. Den blinker, når tørrefasen er i gang.

## A. Lamper

## Programoversigt

Program	Fyldning af opvaskemaskine	Graden af snavs	Temperatur (°C)	Tid (min.)	Valgmuligheder	AutoOpen
 Quick 30'	Service, bestik	Frisk snavs	50	30		✓
 Rinse & Hold	Alle typer opvask	Alle grader af snavs	Koldt vand	15	✗	✗
 60 Minutes	Service, bestik	Frisk, let indtørret snavs	60	60		✓

Program	Fyldning af opvaskemaskine	Graden af snavs	Temperatur (°C)	Tid (min.)	Valgmuligheder	AutoOpen
 90 Minutes	Service, bestik, gryder, pander	Normalt, let indtørret snavs	60	90		✓
 Intensive	Service, bestik, gryder, pander	Normalt til meget indtørret snavs	60	160		✓
<b>ECO</b> 1)	Service, bestik, gryder, pander	Normalt, let indtørret snavs	50	240		✓
<b>AUTO</b>	Service, bestik, gryder, pander	Alt	50 - 60	120 - 170	✗	✓
<b>Machine Care</b>	Rengøring af apparatet indvendigt. Se "Rengøring og vedligeholdelse".		70	60	✗	✓

1) Dette program tilbyder det mest effektive vand- og energiforbrug til service og bestik med normalt snavs. Dette er standardprogrammet til testgennemførsler. Dette program bruges til at vurdere overholdelse af forordningen om miljøvenligt design (EU) 2019/2022.

## Tilvalg

Du kan justere programvalget til dine behov ved at aktivere tilvalg.

### Power Clean

 Power Clean forbedrer opvaskeresultaterne for det valgte program. Tilvalget øger opvasketemperaturen og -varigheden.

### Gentle / Glass

 Gentle / Glass forhindrer sart opvask, især glas, i at blive beskadiget. Muligheden forhindrer hurtige ændringer i det valgte programs opvasketemperatur og reducerer den til 45 °C.

## Grundindstillinger



Nummer	Indstilling	Indstillingsværdi	Vandets hårdhed	
			mmol/l	Tyske grader (°dH)
1	Blødgøringsanlæg	10	8.4 - 9.0	47 - 50
		9	7.6 - 8.3	43 - 46
		8	6.5 - 7.5	37 - 42
		7	5.1 - 6.4	29 - 36
		6	4.0 - 5.0	23 - 28
		5 1)	3.3 - 3.9	19 - 22
		4	2.6 - 3.2	15 - 18
		3	1.9 - 2.5	11 - 14
		2	0.7 - 1.8	4 - 10
	1 2)	<0.7	<4	
2	Afspændingsmiddelniveau	0A - 8A		

3	Slutlyd	1b (tændt) / 0b (slukket)
4	Automatisk døråbner	1o (tændt) / 0o (slukket)
5	Panel signaler	1F (tændt) / 0F (slukket)
6	Senest valgte program	1H (tændt) / 0H (slukket)





1) Fabriksindstilling.

2) Brug ikke salt på dette niveau.

## Indstillingstilstand

Knap	Beskrivelse
 1h	Forrige-knap. Tryk for at skifte mellem grundindstillingerne og for at ændre deres værdi.
	OK-knap. Tryk for at gå ind i den valgte indstilling og for at bekræfte ændringen af dens værdi.
	Næste-knap. Tryk for at skifte mellem grundindstillingerne og for at ændre deres værdi.

## Sådan ændres en indstilling

- Tryk på  30' og **ECO** og hold dem nede samtidigt i ca. 3 sekunder for at gå ind i indstillingstilstand.
  - Lysene: ,  og  er tændt.
  - Displayet viser den aktuelle værdi af den først tilgængelige indstilling.
- Tryk på **Forrige** eller **Næste** for at vælge indstillingen.  
Displayet viser den aktuelle indstillingsværdi (et tal og det dedikerede bogstav).
- Tryk på **OK** for at åbne indstillingen.  
Den nuværende indstillingsværdi blinker.
- Tryk på **Forrige** eller **Næste** for at ændre værdien.
- Tryk på **OK** for at bekræfte indstillingsværdien.
  - Den nye indstillingsværdi gemmes.
  - Maskinen vender tilbage til listen over grundindstillinger.
- Tryk på  30' og **ECO** og hold dem nede samtidigt i ca. 3 sekunder for at forlade indstillingstilstand.

Apparatet skifter til programvalget.

## AutoOpen

AutoOpen forbedrer tørreresultaterne med mindre energiforbrug. Lågen til maskinen åbnes automatisk under tørrefasen og forbliver på klem.

 **Forsigtig!** Forsøg ikke at lukke opvaskemaskinens låge inden for 2 minutter efter automatisk åbning. Det kan beskadige maskinen.

 **Forsigtig!** Hvis børn, kæledyr eller personer med handicap har adgang til apparatet, skal du deaktivere AutoOpen. Den automatiske åbning af lågen kan udgøre en fare og udsætte eventuelle farer i apparatet (f.eks. knive, skarpe genstande, kemikalier).

## Før brug første gang

Sørg for, at blødgøringsanlæggets strømniveau passer til vandforsyningens hårdhed.

Brug programmet Quick 30' til at fjerne rester fra fremstillingsprocessen.

- Hæld 1 liter vand i saltbeholderen.
- Hæld 1 kg salt i saltbeholderen.  
Brug groft salt, der kun er beregnet til opvaskemaskiner.
- Påfyldning af kammeret til afspændingsmiddel
- Åbn vandhanen.
- Vælg programmet, Quick 30' og luk opvaskemaskinens låge for at starte den.

Brug ikke opvaskemiddel, og fyld ikke service i kurvene.

 **Forsigtig!** Der kan løbe vand og salt ud af saltbeholderen, når du fylder den. Start øjeblikkeligt et program, efter du har fyldt saltbeholderen, for at forhindre korrosion.

 Hvis du ikke bruger apparatet, skal du lukke for vandhanen.

## Fejlfinding

Hvis du støder på et problem med dit apparat, kan du se kapitlet "Fejlfinding" i den

fulde version af brugervejledningen, som findes på: [www.ikea.com](http://www.ikea.com).

## Tekniske oplysninger

Produkttype	Fuldt integreret opvaskemaskine	
Mål	Bredde/højde/dybde (mm)	446 / 818 - 898 / 550
El-forbindelse <sup>1)</sup>	Spænding (V)	220 - 240
	Frekvens (Hz)	50
Vandforsynings-tryk	Min./maks. bar (MPa)	0,5 (0,05) / 10 (1,0)
Vandforsyning	Koldt vand eller varmt vand <sup>2)</sup>	maks. 60°C
Kapacitet	Sæt indstillinger	10

1) Se typeskiltet for andre værdier.

2) Hvis det varme vand leveres af alternativ energikilde (f.eks. solfangere, vindenergi), bruges tilslutning til varmt vand for at spare på energien.

### Link til EU EPREL-databasen

QR-koden på energimærket forsynet med apparatet indeholder et weblink til registreringen af dette apparat i EU EPREL-databasen. Opbevar energimærket til reference sammen med brugervejledningen og alle andre dokumenter, der følger med dette apparat.

Det er muligt at finde information relateret til produktets ydelse i EU EPREL-databasen ved hjælp af linket <https://eprel.ec.europa.eu> og modelnavnet og produktnummeret, som du kan finde på apparatets typeskilt. Se kapitlet "Produktbeskrivelse".

Få mere detaljeret information om energimærket på [www.theenergylabel.eu](http://www.theenergylabel.eu).

## Produktbeskrivelse

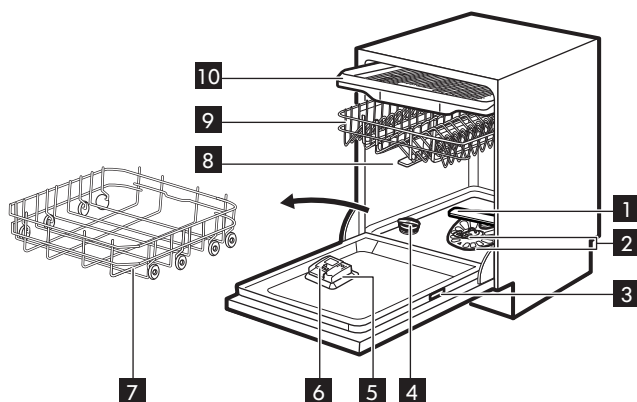

**1** Nedre spylearm

**2** Filtre

**3** Typeskilt

**4** Saltbeholder

**5** Skyllemiddelbeholder

**6** Oppvaskmiddelbeholder

**7** Nedre kurv

**8** Øvre spylearmer

**9** Øvre kurv

**10** Bestikkskuff

### Beam-on-Floor

Beam-on-Floor er et lys som vises på gulvet under produktets dør.

- Når programmet starter, tennes et hvitt lys og lyser så lenge programmet varer.
- Når programmet er ferdig, slukkes det hvite lyset.

- Når produktet har en feil, vil det hvite lyset blinke.

**i** Beam-on-Floor er slått av mens produktet er deaktivert.

## Betjeningspanel

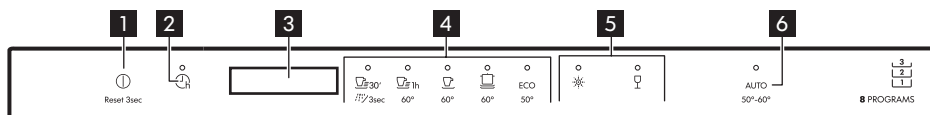

- 1** På/Av-knapp / Tilbakestillingsknapp
- 2** Starttidsforvalg-knapp
- 3** Display
- 4** Program-knapper

- 5** Tilvalg-knapp
- 6** AUTO programknapp

## Visning

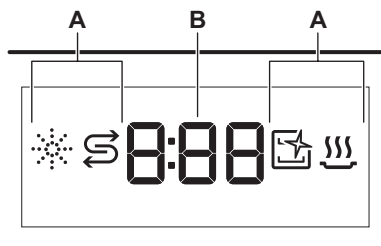



- A.** Indikatorer
- B.** Tidsindikator

## Indikatorer

Indikator	Beskrivelse
	Skyllemiddelindikator. Den tennes når skyllemiddelbeholderen er tom.
	Saltindikator. Den tennes når saltbeholderen er tom.
	Machine Care-indikator. Den tennes når apparatet trenger å rengjøres innvendig med programmet Machine Care.
	Indikator for tørkefase. Den tennes når et program med tørkefasen er valgt. Den blinker under tørkefasen er i gang.

## Programoversikt

Program	Oppvaskmaskin-last	Grad av smuss	Temperatur (°C)	Tid (min.)	Tilvalg	AutoOpen
Quick 30'	Servise, bestikk	Nytt smuss	50	30	 	✓
Rinse & Hold	Alle typer vask	Alle grader av smuss	Kaldt vann	15	X	X
60 Minutes	Servise, bestikk	Fersk, lett tørket smuss	60	60	 	✓
90 Minutes	Servise, bestikk, gryter, panner	Normal, lett tørket på smuss	60	90	 	✓

Program	Oppvaskmaskinlast	Grad av smuss	Temperatur (°C)	Tid (min.)	Tilvalg	AutoOpen
 Intensive	Servise, bestikk, gryter, panner	Normal til tung, tørket smuss	60	160		✓
ECO 1)	Servise, bestikk, gryter, panner	Normal, lett tørket på smuss	50	240		✓
AUTO	Servise, bestikk, gryter, panner	Alle	50 - 60	120 - 170	X	✓
Machine Care	For rengjøring av innsiden av produktet. Se «Rengjøring og vedlikehold».		70	60	X	✓

1) Dette programmet gir deg mest mulig effektivt vann- og energiforbruk for normalt skittent bestikk og servise. Dette er standardprogrammet for testinstitutter. Dette programmet brukes til å vurdere samsvar med Ecodesign Comission forordning (EU) 2019/2022.

## Alternativer

Du kan endre programvalget etter behov ved å aktivere alternativer.

### Power Clean

 Power Clean forbedrer oppvaskresultatene av det valgte programmet. Tilvalget øker vasketemperaturen og varigheten.

### Gentle / Glass

 Gentle / Glass hindrer at ømtålelige ting, spesielt glass skades. Tilvalget forhindrer hurtige endringer i oppvasktemperaturen til det valgte programmet og reduserer det til 45 °C.

## Grunnleggende innstillinger



Tall	Innstilling	Innstillingsverdi	Vannhardhet	
			mmol/l	Tyske grader (°dH)
1	Vannmykner	10	8.4 - 9.0	47 - 50
		9	7.6 - 8.3	43 - 46
		8	6.5 - 7.5	37 - 42
		7	5.1 - 6.4	29 - 36
		6	4.0 - 5.0	23 - 28
		5 1)	3.3 - 3.9	19 - 22
		4	2.6 - 3.2	15 - 18
		3	1.9 - 2.5	11 - 14
		2	0.7 - 1.8	4 - 10
		1 2)	<0.7	<4
2	Skyllemiddelnivå	0A - 8A		
3	Sluttlyd	1b (på) / 0b (av)		
4	Automatisk døråpner	1o (på) / 0o (av)		

5	Tastelyder	1F (på) / 0F (av)
6	Siste programvalg	1H (på) / 0H (av)

1) Fabrikkinnstilling.



2) Ikke bruk salt på dette nivået.

## Innstillingsmodus

Knapp	Beskrivelse
 1h	Forrige-knapp Trykk på for å veksle mellom de grunnleggende innstillingene og for å endre verdiene deres.
	OK-knapp Trykk på for å angi den valgte innstillingen og for å bekrefte endringen av verdien dens.
	Neste-knapp Trykk på for å veksle mellom de grunnleggende innstillingene og for å endre verdiene deres.

## Slik endrer du en innstilling

1. For å gå inn i innstillingsmodus, trykk og hold  30' og **ECO** samtidig i omtrent 3 sekunder.

- Lampene:  1h,  og  er på.
- Displayet viser den gjeldende verdien for første tilgjengelige innstilling.

2. Trykk på **Forrige** eller **Neste** for å velge innstillingen.

Displayet viser gjeldende innstillingsverdi (et siffer og den dedikerte bokstaven).

3. Trykk på **OK** for å endre innstillingen. Den gjeldende innstillingsverdien blinker.

4. Trykk på **Forrige** eller **Neste** for å endre verdien.

5. Trykk på **OK** for å bekrefte innstillingsverdien.

- Den nye innstillingsverdien lagres.
- Apparatet går tilbake til listen for grunnleggende innstillinger.

6. Trykk og hold  30' og **ECO** nede i omtrent 3 sekunder for å lukke innstillingsmodus.

Produktet bytter til programvalget.

## AutoOpen

AutoOpen forbedrer tørkeresultatet med mindre strømforbruk. Døren åpner seg automatisk under tørkesyklusen og blir stående åpen.

 **FORSIKTIG!** Ikke prøv å lukke døren før etter 2 minutter etter en automatisk åpning. Dette kan skade produktet.

 **FORSIKTIG!** Hvis barn, kjæledyr eller personer med funksjonshemninger har tilgang til produktet, må du deaktivere AutoOpen. Den automatiske åpningen av døren kan utgjøre en fare og utsette mulige farer inne i produktet (som kniver, skarpe gjenstander, kjemikalier).

## Før første gangs bruk

Sørg for at det aktuelle nivået på vannmykneren er justert i forhold til vannhardheten.

Bruk programmet Quick 30' til å fjerne rester fra produksjonsprosessen.

1. Hell 1 liter vann i saltbeholderen.
2. Hell 1 kg salt i saltbeholderen. Bruk salt som bare er beregnet for oppvaskmaskiner.
3. Fyll skyllemiddelbeholderen.
4. Åpne vannkranen.
5. Velg Quick 30'-programmet og lukk oppvaskmaskindøren for å starte det.

Bruk ikke oppvaskmiddel og sett ikke oppvask i kurvene.

 **FORSIKTIG!** Det kan komme vann og salt ut av saltbeholderen når du fyller den. For å forhindre korrosjon, må du starte et program umiddelbart etter at du har fylt saltbeholderen.

 Hvis du ikke bruker produktet, kan du lukke vannkranen.

## Feilsøking

Hvis du støter på et problem med produktet, sjekk kapittelet "Feilsøking" i den

fullstendige versjonen av bruksanvisningen som er tilgjengelig på: [www.ikea.com](http://www.ikea.com).



## Tekniske data

Produkttype	Helintegrert oppvaskmaskin	
Mål	Bredde / høyde / dybde (mm)	446 / 818 - 898 / 550
Elektrisk tilkobling <sup>1)</sup>	Spenning (V)	220 – 240
	Frekvens (Hz)	50
Vannforsynings-trykk	Min. / maks. bar (MPa)	0.5 (0.05) / 10 (1.0)
Vannforsyning	Kaldt vann eller varmt vann <sup>2)</sup>	maks 60° C
Kapasitet	Kuverter	10

1) Referer til klassifiseringsskiltet for andre verdier.

2) Hvis varmtvannet kommer fra alternativ energikilde (for eksempel solcellepaneler, vindenergi), bruk varmtvannsforsyningen for å redusere strømforbruket.

### Kobling til EU EPREL-databasen

QR-koden på energietiketten som fulgte med produktet, gir en nettløse til registreringen av dette produktet i EU EPREL-databasen. Oppbevar energietiketten kun for henvisning med denne brukerhåndboken samt alle andre dokumenter som fulgte med dette produktet.

Det er også mulig å finne informasjonen relatert til ytelsen til produktet i EU EPREL-databasen med koblingen <https://eprel.ec.europa.eu> og modellnavnet, samt produktnummeret som du finner på merkeskiltet til produktet. Se etter i kapitlet «Produktbeskrivelse».

Gå til [www.theenergylabel.eu](http://www.theenergylabel.eu) for mer detaljert informasjon om energietiketten.

## Tuotekuvaus

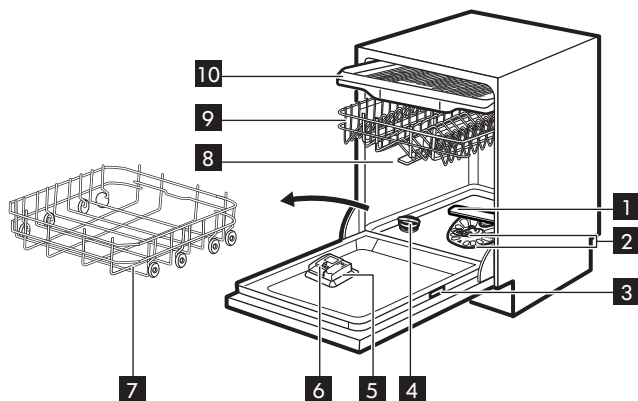

- 1** Alempi suihkuvarsi
- 2** Sihdit
- 3** Arvokilpi
- 4** Suolalokero
- 5** Huuhtelukirkasteen annostelija
- 6** Pesuaineen annostelija

- 7** Alempi kori
- 8** Ylemmät suihkuvarret
- 9** Ylempi kori
- 10** Ruokailuvälinelokero

### Beam-on-Floor

Beam-on-Floor on valo, joka heijastuu lattiaan laitteen luokun alapuolelle.

- Kun ohjelma käynnistyy, valkoinen merkkivalo syttyy ja se pysyy päällä ohjelman keston ajan.
- Kun ohjelma päättyy, valkoinen merkkivalo sammuu.

- Jos laitteessa on toimintahäiriö, valkoinen merkkivalo vilkkuu.

- i** Beam-on-Floor on pois päältä, kun laite kytketään pois toiminnasta.

## Käyttöpaneeli

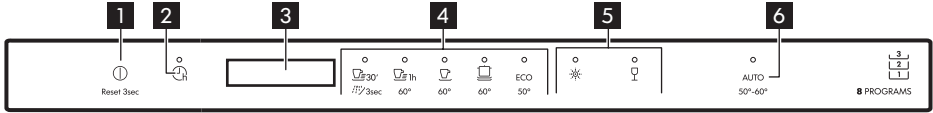

- 1 Virtapainike / nollauspainike
- 2 Ajustimen painike
- 3 Näyttö
- 4 Ohjelmanvalintapainikkeet

- 5 Lisätoimintojen painikkeet
- 6 AUTO Ohjelmanvalintapainike

## Näyttö

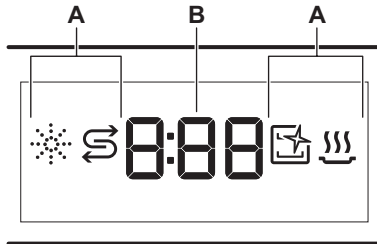



- A. Merkkivalot
- B. Kello

## Merkkivalot

Merkkivalo	Kuvaus
	Rypistymiseneston merkkivalo. Palaa, kun huuhtelukirkastelokeron täyttö on tarpeen.
	Suolan merkkivalo. Palaa, kun suolalokeron täyttö on tarpeen.
	Machine Care -merkkivalo. Palaa, kun laitteen sisäosan puhdistus Machine Care -ohjelmalla on tarpeen.
	Kuivausvaiheen merkkivalo. Palaa, kun valitset kuivausvaiheen sisältävän ohjelman. Viilkuu kuivausvaiheen ollessa käynnissä.

## Ohjelmien yleiskatsaus

Ohjelma	Täytetty astianpesukoneellinen	Likaisuusaste	Lämpötila (°C)	Kellonaika (min)	Lisätoiminnot	AutoOpen
 Quick 30'	Astiasto ja ruokailuvälineet	Äskettäin likaantuneet	50	30	 	✓
 Rinse & Hold	Kaikenlaiset astiat	Kaikki likaisuusasteet	Kylmä vesi	15	✗	✗
 60 Minutes	Astiasto ja ruokailuvälineet	Tuore, hieman kiinni kuivunut liika	60	60	 	✓
 90 Minutes	Astiasto, ruokailuvälineet, kattilat, pannut	Tavallinen määrä, hieman kiinni kuivunut liika	60	90	 	✓

Ohjelma	Täytetty astianpesukoneellinen	Likaisuusaste	Lämpötila (°C)	Kellonaika (min)	Lisätoiminnot	AutoOpen
 Intensive	Astiasto, ruokailuvälineet, kattilat, pannut	Tavallinen tai suuri määrä, kiinni kuivunut lika	60	160		✓
ECO 1)	Astiasto, ruokailuvälineet, kattilat, pannut	Tavallinen määrä, hieman kiinni kuivunut lika	50	240		✓
AUTO	Astiasto, ruokailuvälineet, kattilat, pannut	Kaikki	50 - 60	120 - 170	✗	✓
Machine Care	Laitteen sisäosan puhdistus. Katso kohta "Puhdistus ja ylläpito".		70	60	✗	✓

1) Tämä ohjelma pesee likaiset astiat ja ruokailuvälineet tehokkaimmalla veden- ja energiankulutuksella. Tämä on testilaitosten standardiohjelma. Tätä ohjelmaa on käytetty arvioitaessa, noudattaako laite Ecodesign Commission (ekologisen suunnittelun komission) asetusta (EU) 2019/2022.

### Lisätoiminnot

Voit säätää ohjelmavalinnan omien tarpeidesi mukaan kytkemällä lisätoimintoja toimintaan.

#### Power Clean

 Power Clean parantaa valitun ohjelman astianpesutulosta. Lisätoiminto nostaa pesulämpötilaa ja pidentää kestoja.

### Gentle / Glass

 Gentle / Glass estää helposti rikkoutuvien astioiden, erityisesti lasitavaran, vahingoittumisen. Se estää valitun ohjelman pesulämpötilan äkilliset muutokset ja laskee valitun ohjelman lämpötilan arvoon 45 °C.

## Perusasetukset



Numero	Asetus	Asetusarvo	Veden kovuus	
			mmol / l	Saksalaiset asteet (°dH)
1	Vedenpehmentin	10	8.4 - 9.0	47 - 50
		9	7.6 - 8.3	43 - 46
		8	6.5 - 7.5	37 - 42
		7	5.1 - 6.4	29 - 36
		6	4.0 - 5.0	23 - 28
		5 1)	3.3 - 3.9	19 - 22
		4	2.6 - 3.2	15 - 18
		3	1.9 - 2.5	11 - 14
		2	0.7 - 1.8	4 - 10
	1 2)	<0.7	<4	
2	Huuhtelukirkasteen taso	0A - 8A		
3	Lopetusäänimerkki	1b (päälle) / 0b (pois)		

4	Autom. luukun avaus	1o (päälle) / 0o (pois)
5	Painikenaänet	1F (päälle) / 0F (pois)
6	Viimeisin ohjelmavalinta	1H (päälle) / 0H (pois)





1) Tehdasasetus:

2) Älä käytä suolaa tällä tasolla.

### Asetustila

-painike	Kuvaus
 1h	Edellinen -painike. Voit selata perusasetuksia ja säätää niiden arvoja painamalla.
	OK -painike. Voit siirtyä valittuun asetukseen ja vahvistaa sen arvon muutoksen painamalla.
	Seuraava -painike. Voit selata perusasetuksia ja säätää niiden arvoja painamalla.

## Asetuksen muuttaminen

1. Paina ja pidä painettuina samanaikaisesti painikkeita  ja **ECO** noin kolmen sekunnin ajan päästäksesi asetustilaan.
  - Merkkivalot: ,  ja  ovat päällä.
  - Näytössä näkyy ensimmäisen käytettävissä olevan asetuksen nykyinen arvo.
2. Valitse asetus painamalla **Edellinen** tai **Seuraava**.  
Näytöllä näkyy nykyinen asetusarvo (numero ja määrätty kirjain).
3. Syötä asetus painamalla **OK**.  
Valittu asetusarvo vilkkuu.
4. Vaihda arvoa **Edellinen-** tai **Seuraava-** painikkeella.
5. Vahvista asetusarvo painamalla **OK**.
  - Uusi asetusarvo tallentuu muistiin.
  - Laite palaa perusasetuksien luetteloon.
6. Paina ja pidä painettuina samanaikaisesti painikkeita  ja **ECO** noin kolmen sekunnin ajan poistuaksesi asetustilasta.

Laite vaihtaa ohjelmavalintaan.

## AutoOpen

AutoOpen parantaa kuivaustulosta pienemmällä energiankulutuksella. Laitteen luukku avautuu automaattisesti kuivausvaiheen aikana ja jää raolleen.

 **HUOMIO!** Älä yritä sulkea laitteen luukkuja 2 minuutin kuluessa sen automaattisesta avautumisesta. Jos teet niin, laite voi vaurioitua.

 **HUOMIO!** Jos lapset, lemmikit tai vammaiset voivat päästä käsiksi laitteeseen, deaktivoi eli poista AutoOpen käytöstä. Luukun automaattinen avautuminen voi aiheuttaa vaaran ja paljastaa mahdolliset vaarat laitteen sisällä (kuten veitset, terävät esineet, kemikaalit).

## Ennen ensikäyttöä

Varmista, että vedenpehmentimen nykyinen taso on säädetty vastaamaan käyttöveden kovuutta.

Käynnistä Quick 30'-ohjelma valmistusprosessin jäämien poistamiseksi.

1. Kaada 1 litra vettä suola-astiaan.
2. Laita 1 kg suolaa suola-astiaan.  
Käytä ainoastaan astianpesukoneisiin tarkoitettua karkeaa suolaa.
3. Täytä huuhtelukirkasteastia.
4. Avaa vesihana.
5. Valitse ohjelma Quick 30' ja sulje astianpesukoneen luukku

käynnistäaksesi sen. Älä käytä pesuainetta tai aseta astioita koreihin.

 **HUOMIO!** Vettä ja suolaa voi tulla ulos suolasäiliöstä, kun täytät sen. Käynnistä ohjelma välittömästi suolasäiliön täyttämisen jälkeen korroosion estämiseksi.

 Jos et käytä laitetta, sulje vesihana.

## Vianmääritys

Jos laitteessasi on ongelmia, tarkista luku "Vianmääritys" käyttöoppaan täydestä

versiosta, joka on saatavilla osoitteessa: [www.ikea.com](http://www.ikea.com).

## Tekniset tiedot

Tuotetyyppi	Täysin integroitu astianpesukone	
Mitat	Leveys / korkeus / syvyys (mm)	446 / 818 - 898 / 550
Sähkökytkentä 1)	Jännite (V)	220 - 240
	Taajuus (Hz)	50
Vedenpaine	Vähimm. / enimm. baaria (MPa)	0.5 (0.05) / 10 (1.0)
Vedensyöttö	Kylmä vesi tai kuuma vesi 2)	enint. 60 °C
Tilavuus	Astia-astiojen lukumäärä	10

1) Katso muut arvot arvokilvestä.

2) Jos vesi kuumennetaan vaihtoehtoisen, ympäristöystävällisemmän energian avulla (esim. aurinkopaneeleilla tai eolisella energialla), käytä kuumaa vettä energiankulutuksen vähentämiseksi.

### Linkki EU EPREL -tietokantaan

Laitteen mukana toimitetun energialuokkamerkinnän QR-koodi sisältää linkin verkkosivustolle, jossa tämä laite voidaan rekisteröidä EU EPREL -tietokantaan. Säilytä energialuokkamerkintää yhdessä käyttöohjeen ja kaikkien muiden tämän laitteen mukana toimitettujen asiakirjojen kanssa.

Tuotteen suorituskykytietoja on mahdollista tarkastella EU EPREL -tietokannassa käyttämällä linkkiä <https://eprel.ec.europa.eu> sekä laitteen arvokilvessä olevaa mallin nimeä ja tuotenumeroa. Katso luku "Tuotteen kuvaus".

Lisätietoa energialuokasta on saatavilla osoitteesta [www.theenergylabel.eu](http://www.theenergylabel.eu).

## Produktbeskrivning

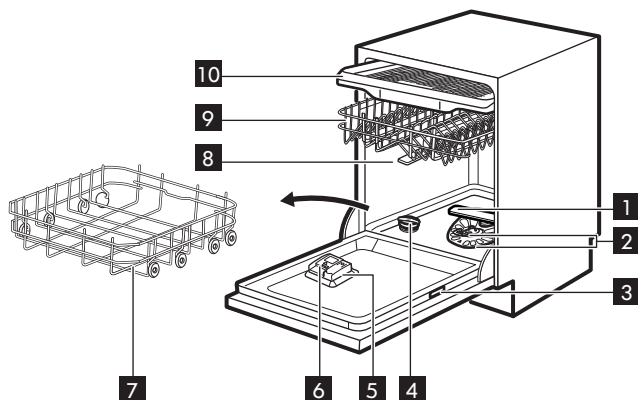

- 1** Nedre spolarm
- 2** Filter
- 3** Typskylt
- 4** Saltbehållare
- 5** Spolglansbehållare
- 6** Diskmedelsfack

- 7** Nedre korg
- 8** Övre spolarmar
- 9** Övre korg
- 10** Besticklåda

### Beam-on-Floor

Indikatorn Beam-on-Floor projiceras på golvet under produktens lucka.

- När programmet går igång tänds en vit lampa som fortsätter lysa under hela programmet.

- När programmet är klart släcks den vita lampan.
- Om produkten drabbas av ett fel blinkar den vita lampan.

**i** Beam-on-Floor är släckt när produkten är avstängd.

## Kontrollpanel

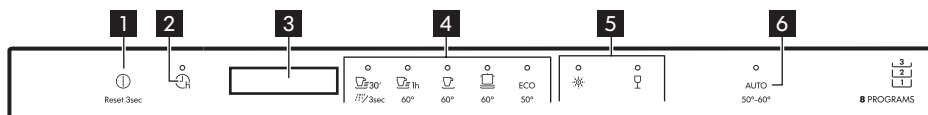

- 1** On/Off-knapp/återställningsknapp
- 2** Knapp för fördröjd start
- 3** Display
- 4** Programvalsknappar

- 5** Funktionsknappar
- 6** AUTO programknapp

## Display

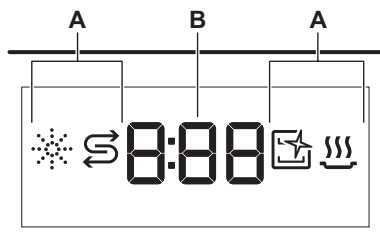

- A.** Indikatorlampor
- B.** Tidsindikator



## Indikatorer

Indikator	Beskrivning
	Indikator för spolglans. Den lyser när spolglans behöver fyllas på.
	Saltindikator. Den lyser när saltbehållaren behöver fyllas på.
	Machine Care indikator. Den lyser när maskinen behöver rengöras inuti med Machine Care-programmet.
	Indikator för torkfas. Den lyser när ett program med en torkfas har valts. Den blinkar när torkfasen pågår.

## Programöversikt

Program	Diskmaskinsladdning	Smutsgrad	Temperatur (°C)	Tid (min)	funktioner	AutoOpen
 Quick 30'	Porslin, bestick	Nyligen nedsmutsad disk	50	30	 	✓
 Rinse & Hold	Alla typer av disk	Alla smutsgrader	Kallt vatten	15	✗	✗
 60 Minutes	Porslin, bestick	Nyligen lätt in-torkad smuts	60	60	 	✓
 90 Minutes	Porslin, bestick, kastruller, pannor	Normalt lätt in-torkad smuts	60	90	 	✓



Program	Diskmaskinsladdning	Smutsgrad	Temperatur (°C)	Tid (min)	funktioner	AutoOpen
 Intensive	Porslin, bestick, kastruller, pannor	Normalt till hårt intorkad smuts	60	160		✓
ECO 1)	Porslin, bestick, kastruller, pannor	Normalt lätt intorkad smuts	50	240		✓
AUTO	Porslin, bestick, kastruller, pannor	Alla	50 - 60	120 - 170	X	✓
Machine Care	Rengöring av apparatens insida. Se "Rengöring och underhåll".		70	60	X	✓

1) Med det här programmet får du den mest effektiva vattenanvändningen och energiförbrukningen för normalt nedsmutsat porslin och bestick. Detta är standardprogrammet för testinstitut. Det här programmet används för att bedöma överensstämmelse med förordningen om ekodesign (EU) 2019/2022.

## Alternativ

Du kan ändra programval efter dina behov genom att aktivera funktioner.

### Power Clean

 Power Clean förbättrar diskresultatet för valt program. Alternativet ökar temperaturen och programlängden.

### Gentle / Glass

 Gentle / Glass förhindrar att ömtåliga föremål, särskilt glas, skadas. Alternativet undviker snabba temperaturändringar i valt program och minskar temperaturen till 45 °C.

## Normalinställningar



Nummer	Inställning	Inställningsvärde	Vattenhårdhet	
			mmol/l	Tyska värden (°dH)
1	Vattenavhårdare	10	8.4 - 9.0	47 - 50
		9	7.6 - 8.3	43 - 46
		8	6.5 - 7.5	37 - 42
		7	5.1 - 6.4	29 - 36
		6	4.0 - 5.0	23 - 28
		5 1)	3.3 - 3.9	19 - 22
		4	2.6 - 3.2	15 - 18
		3	1.9 - 2.5	11 - 14
		2	0.7 - 1.8	4 - 10
	1 2)	<0.7	<4	
2	Spolglansnivå	0A - 8A		
3	Sluttjud	1b (på) / 0b (av)		
4	Aut. lucköppn.	1o (på) / 0o (av)		
5	Knappljud	1F (på) / 0F (av)		

6	Senaste programvalet	1H (på) / 0H (av)
---	----------------------	-------------------

1) Fabriksinställning.



2) Använd inte salt på denna nivå.

## Inställningsläge

Knapp	Beskrivning
 1h	Föregående-knapp. Tryck för att växla mellan normalinställningar och ändra deras värden.
	OK-knapp. Tryck för att öppna vald inställning och bekräfta ändring av värdet.
	Nästa-knapp. Tryck för att växla mellan normalinställningar och ändra deras värden.

## Ändra en inställning

- Tryck och håll in  30' och **ECO** samtidigt i ca 3 sekunder för att öppna inställningsläget.

• Lamporna:  1h,  och  är på.

- Displayen visar det aktuella värdet för den första tillgängliga inställningen.
- 2. Tryck på **Föregående** eller **Nästa** för att välja inställning.  
Displayen visar det aktuella inställningsvärdet (en siffra och den dedikerade bokstaven).
- 3. Tryck på **OK** för att aktivera inställningen. Aktuellt inställningsvärde blinkar.
- 4. Tryck på **Föregående** eller **Nästa** för att ändra värdet.
- 5. Tryck på **OK** för att bekräfta inställningsvärdet.
  - Det nya inställningsvärdet sparas.
  - Produkten återgår till normalinställningslistan.
- 6. Tryck och håll in  och **ECO** samtidigt i ca 3 sekunder för att lämna inställningsläget.

Produkten växlar till programval.

## AutoOpen

AutoOpen förbättrar torkningsresultatet med lägre energiförbrukning. Under

## Före första användning

Kontrollera att vattenavhjärdarens aktuella nivå överensstämmer med vattentillförselns hårdhet.

Använd programmet Quick 30' att ta bort rester från tillverkningsprocessen.

1. Häll 1 liter vatten i saltbehållaren.
2. Häll 1 kg salt i saltbehållaren. Använd endast grovt salt avsett för diskmaskinen.
3. Fyll på spolglansfacket.
4. Öppna vattenkranen.
5. Välj program Quick 30' och stäng diskmaskinens lucka för att starta det.

torkningsfasen öppnas luckan automatiskt och lämnas på glänt.



**FÖRSIKTIGHET!** Försök att inte stänga luckan inom 2 minuter efter att den har öppnats automatiskt. Det kan skada maskinen.



**FÖRSIKTIGHET!** Inaktivera AutoOpen om barn, husdjur eller personer med funktionsnedsättning har tillgång till produkten. Den automatiska öppningen av luckan kan utgöra en fara och exponera potentiella faror inuti produkten (t.ex. knivar, vassa föremål, kemikalier).

Använd inte diskmedel och ladda inte korgarna med disk.



**FÖRSIKTIGHET!** Vatten och avhärddningssalt kan rinna ut från saltbehållaren när du fyller på den. När du har fyllt på saltbehållaren ska du starta ett program genast för att förhindra rost.



Stäng vattenkranen om du inte använder apparaten.

## Felsökning

Om du stöter på ett problem med din produkt, se kapitlet "Felsökning" i den fullständiga versionen av

användarhandboken som finns på: [www.ikea.com](http://www.ikea.com).

## Teknisk information

Produkttyp	Helintegrerad diskmaskin	
Mått	Bredd / Höjd / Djup (mm)	446 / 818 - 898 / 550
Elanslutning <sup>1)</sup>	Spänning (V)	220 - 240
	Frekvens (Hz)	50
Vattentryck	Min./max. bar (MPa)	0.5 (0.05) / 10 (1.0)
Vattenförsörjning	Kallt vatten eller varmt vatten <sup>2)</sup>	max 60 °C
Kapacitet	Kuvert	10

1) Se märkskylten för andra värden.

2) Om varmvattnet kommer från en alternativ energikälla (t.ex. solpaneler eller vindkraft) kan en varmvattensanslutning användas för att minska energiförbrukningen.

### Länk till EU EPREL databas

QR-koden på energimärkningsetiketten som levereras med produkten ger en webblänk till registreringen av denna produkt i EU EPREL-databasen. Förvara energimärkningsetiketten som referens tillsammans med användarhandboken och alla andra dokument som medföljer denna produkt.

Det går att hitta information relaterad till produktens prestanda i EU EPREL-databasen med hjälp av länken <https://eprel.ec.europa.eu> och modellnamnet och produktnumret som du kan hitta på maskinens typskylt. Se kapitlet "Produktbeskrivning".

För mer detaljerad information om energimärkning, gå in på [www.theenergylabel.eu](http://www.theenergylabel.eu).



156809931-A-282022

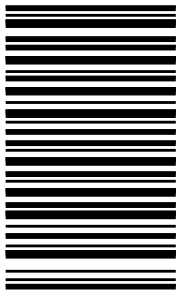

© Inter IKEA Systems B.V. 2022

21552

AA-2316389-2